

Mass and Volumes for a Spectrum of Multistage Evolving Space Farms

Bryce L. Meyer¹

Feeding the settlers, and fully recycling the gasses and wastes from a settlement, will require a complex set of biological organisms and machinery. Previous papers have focused on the basic shape and simple species compositions of a four stage farm that uses two bioreactors (Yeast-Bacteria, and Algae), a Hydroponic Stage, and an Aquatic Stage, for set points in a settlement's development. Modelling software has emerged from this work that has been expanded to allow more detailed scenarios, and detailed nutritional considerations. More species have been added, including potatoes (by popular request), and the ability to consider pre-supplied key masses (to allow growth for supply in a space economy). Additionally, between these stages are a series of machines, tanks, and controls that must be considered, and these are discussed and diagramed. Therefore, mass flows are the core to keeping all organisms alive, and this work considers the mass flows, key flow control equipment, and sizing for a spectrum of space farms evolving from a simple initial station to a full-fledged growing and supplying settlement, using at maturity a dozen species. The paper will also provide trade-offs in in-situ materials for continued operation, key dynamics, and sizing.

Nomenclature

Primary Mass Components (Capitalized for a whole stage. lowercase for per capita values.):

B_i = dry biomass input to living biomass

B_o = dry biomass output to living biomass

$B_{o,g}$ = dry biomass grown in a stage that is output by a species

$B_{o,g,inedible}$ = dry biomass by living mass output as living biomass (grown) that is inedible to humans.

$B_{o,g,edible}$ = dry biomass by living mass output as living biomass (grown) that is edible to humans (i.e. crop)

$B_{o,e}$ = dry biomass by living mass output as excretions

C_i = carbon dioxide (CO₂) input by living mass

C_o = carbon dioxide (CO₂) output by living mass

d = ratio of wet (live) biomass to dry biomass.

F = total stage footprint (square meters).

L_{crop} = living biomass (wet) of the crop

L_{tot} = living biomass (wet) of the whole stage

M = stage total mass multiplier (multiplies living biomass)

M_w = total water mass multiplier for water in a stage not locked into biomass.

O_i = oxygen gas (O₂) input by living mass

O_o = oxygen gas (O₂) output by living mass

$T_{harvest}$ = time in days to harvest (aka growth time).

Q = population growth multiplier.

V = stage volume multiplier from total living biomass (kg to cubic meters).

W_i = water (H₂O) input by living mass

W_o = water (H₂O) output by living mass

¹ NSS Member, and Member of Saint Louis Space Frontier

I. Introduction

Space Settlements will progress through a series of levels, as they grow more economically independent and self-sufficient. Initial stations will follow a progression in levels to full-fledged settlements as shown below in Table 1, likewise for their space recycling and farming capability. An initial settlement (Level 0, an outpost) is composed of adventurous adults, while later settlements see multi-generational age diversity and reproduction (Level 3). Resorts are similar. A resort is a place to temporarily stay, largely for recreation, though its definition follows those who work there and the food available. Labor for early levels is on rotation, and serves a very limited menu of pre-packaged foods (Level 1). This resort is very different than a resort that has local produce, with people who live with their families on site (Level 4). The primary purpose of the space farm in the context of each evolutionary level of settlements or resorts is to fully recycle carbon dioxide, water, and liquid and solid human wastes, into oxygen, clean water, and a variety of nutritious foods, as much as possible given conditions. The farm therefore must efficiently, in materials and volume, take the settlers mass flows and make food, water, air. Human mass outputs are a biochemical mix of carbon dioxide, fats, minerals, indigestible carbohydrates (including cellulose), urea, proteins and amino acids, and dirty water. The mass conversion in the farm uses both high surface area bioreactors of aerobic, anaerobic, and photosynthetic cells, and the living bioreactors of vascular plants, and animals to perform chemical conversion. As a result, mass flows from the farm must supply foods that meet the minimum U.S. Recommended Daily Allowance (US RDA) for key categories, including at least 2,000 kilocalories (kcal) per day, plus water, and oxygen, totaling ~6.1 kg input per person on average per day, or 606 kg for 100 people per day (described further herein).

Each evolutionary level in a space settlement has different needs, as does any attendant resort as shown in Table 1. Notice that there is a substantial lag between a settlement and a resort. Initial resorts are like base camps and remote outposts with resupply and primitive recycling, where luxury foods are from Earth or other better settled areas. Once a settlement is established and in sustaining mode, the resort's foods can become less pre-processed and more freshly grown, increasingly sourced on site. By the time a settlement has reached Settlement Level 3, tourists and workers live on local flavor, and the resort is only one portion of the overall destination experience. From a settler perspective, the resort and its settlement are only one customer set for farm produce.

In all cases, the farm that supports a settlement is all about mass balance, requiring more than just a traditional Earth farm's equipment. While animals and humans can breakdown and convert amino acids and proteins, they will need the elemental materials. The rate of flow from and to the settlement will need to buffer from the rest of the farm using separators, pumps, tanks, and macerators for wastes, and storage (controlled temperature), pumps, and tanks into the habitat. The habitat itself can do grey water recycling using inside settlement grown vines and trees, and sterilizers, and return inert gasses and condensed humidity. The needs and construction of the farm shift as the settlement evolves.

In turn, the farm becomes a biochemical factory for converting masses. Each portion of the space farm, or stage, consists of an isolated environment optimized for the organisms inside, and recirculating materials internally, accepting a flow of inputs, and delivering a flow of outputs from the settlement or other stages.

There are four stage types in the farm: Algae Reactors, a Yeast-Bacteria Reactor, Hydroponic Stages, and Aquatic Stages. The Algae Reactors will convert carbon dioxide, water, nutrients, and light, into algae cells and oxygen. There are multiple Algae Reactors, each using a membrane/mesh and high light exposure design, to grow a species of algae per reactor. Various algae species provide different biochemical input and output profiles and growth rates per living kilogram. The Yeast-Bacteria Reactor is a complex bioreactor series using classic vat structures, with high surface area membrane mediated flow reactors, designed to balance the farm's biochemistry, though in the scenarios to date, it primarily converts biomass, including and especially cellulose, and excess oxygen, into water and carbon dioxide for other stages. In early colonies the output will be yeast biomass for human food. The Hydroponic Stages are fully enclosed soil-less gardens using root tubes or shapes of immersed and moistened marbles, fiber, or gravel, seeded with aerobic bacteria and root fungi, and high exposure controlled spectrum lights distributed not just above, but all around the photosynthetic structures of the plants, in a carbon-dioxide rich environment. Species include legumes, vegetables, and grains. Harvest is timed to be continuous for each crop, using light output, and hormones, i.e. every day some of the crop is harvested, while the rest grows for later harvest. For grains, root crops, and beans, seeding is timed to allow some of the plants to mature every day. For fruiting plants, growth is so that some fruits are collected every day, other fruits left to mature for the next day. Finally, there are Aquatic Stages, consisting of recirculating raceways or pools of fish and invertebrates (shrimps). The animals will crawl or swim as oriented by light and current, with staggered harvest and growth cycles as for plants. For fish and shrimp, some animals are harvested every day, others left to grow out. Spawning can be delayed or timed using light, temperature or hormones.

Table 1. Space settlement and resort levels. Space resort levels precede settlement levels, since settlements trade long term existence versus short term objectives.

Settlement Level	Resort Level	Space Equiv.	Earth Analog (Resort)	Earth Analog (Settlement)	Food Source	Recycling and Farming
0	0	ISS as of 2017, all space outposts to 2017.	Everest Base Camp	Camp	All from Earth	Minimal Chemical Recycling of gases and water. A few ornamental plants. Requires extensive Resupply.
0	1	Inflatable or Basic Orbital Unit/Hotel	Oil Rig, Antarctica Bases.	Camp	All from Earth	Minimal Chemical Recycling of gases and water. Plants as ornamental compliment to diet. Requires extensive Resupply
0	2	Beginning Space Resort	Hotel with amenities.	Camp/Hotel with Garden (no families)	Most from Earth, some local	Some biological recycling of solids, and full recycling (biological/mechanical) of gases and water. Some hydroponic growth. Minimal bioreactors. Requires import for Complex menus.
1	3	Next Level Space Resort	Major Hotel/Resort (Cruise Ship destination/provision)	Farming Transient Town (few families).	Some items Earth, though staples and spice items local.	Complete recycling of solids, liquids, gases. Hydroponics and bioreactors, minimal animal (aquatic or insect). Complex menus combining local sources, with luxury items from off-site
2	4A	Full Space Resort as part of a small settlement.	All inclusive luxury resort as part of a community.	Permanent Growing Town	Majority of foods local. Self Sufficient for all but guests and children. Access to some in-situ or local supplies.	Complete recycling of solids, liquids, gases, very efficiently. Hydroponics, some in-soil in Habitat growth, and bioreactors, many aquatic species (fish, shrimp). Complex menus from local sources, though some resupply for luxury items and inefficiencies.
3	4B	Full Space Resort as part of a growing settlement	All inclusive luxury resort as part of a community and city. Many off resort options.	Permanent Large Growing Town/City with food exports.	Self Sufficient for all but guests and extra pop growth and export. Access to resources for excess production. Part of an economic trade web.	Complex farms (either staged or 'open' air) with diverse species, including crop species for export. Mass flow is efficient for productive farm. Parks with extensive in-soil planting, including limited tree and bush crops and ornamental plants.

Work for this paper has shown that there are a series of required systems to control the operation and flows of masses, due to variations in flow rates between the stages of the farm: a gas management system with oxygen and carbon dioxide legs, tanks, pumps, sterilizers, and gas molecule type separators; a water system, with high nutrient, black water, and clean water legs, also using pumps, filter/separators, and tanks; and a mass-food system, which would include manual or robotic harvest, pruning, and maceration, and cleaning of foods and inedible materials for recycle. Elements of these systems are dispersed into the stages, and linked together by complex control systems.

To select a spectrum of colonies for this paper, four settlement modes are examined: initial settlement (Level 0), where the bioreactors are available, but the rest of the farm is under construction; sustained settlement (Level 1), where a limited set of plants and animals are available, but may require supply of nitrogen-rich materials; steady state settlement with a self-sustaining and minimal resupply farm (Level 2); and a supplying settlement which uses in-situ supplies to create a surplus of key crops, while feeding and supplying itself (Level 3).

This paper illustrates the mass flow and notional designs for each scenario, and a hint at the dietary options for each.

II. Assumptions

The following are a list of high level assumptions for this paper, explained further in the sections below.

1. Energy is readily available, in the form needed for each stage. This can be from a variety of sources, including nuclear.
2. Temperature and pressures are regulated and controlled in each stage to be near optimal.
3. Losses from inefficient seals, destruction of materials, and other inefficiencies are minimal.
4. Only the mass (in the right form) needed by a stage is added, and only mass required is removed.
5. Mass flow is an aggregate for the stage, not mass flow for each individual organism, and partial pressures are controlled to only add and remove mass as required. For example, even though photosynthesis is inefficient for each plant, the sensors and control of the stage (or contained portion thereof) will add and subtract carbon dioxide and oxygen to balance the partial pressure in the stage, to only add carbon dioxide as consumed, and remove oxygen as produced, in aggregate for the stage.
6. The unit is live kilograms to simplify calculation for all organisms, i.e. as if raw or alive, containing water. All populations, other than the humans, are in terms of living biomass (in kilograms).
7. There is perfect control of water and gases in every stage.
8. Plant transpiration is condensed and recirculated to roots in each hydroponic stage.
9. Grey water from human evaporation and breath is condensed and sterilized (using UV or similar) and either re-released into the habitat or sent to the water management system for the farm.
10. Grey water from washing and food preparation is efficiently filtered, the clean, sterilized, liquid recaptured to either the habitat or water system as needed, while highly concentrated waste sent to the waste processing system and Yeast-Bacteria Reactor. Assume perfect transfers. This also assumes fully organic soaps and hygiene products.
11. Inert gasses in the habitat, aquatic stages stay in the stage.
12. Plants and algae are assumed to prefer bioavailable forms of nitrogen in urea, ammonia, and similar nitrates. Nitrogen and nitrogen containing chemicals is initially supplied as calculated below. In animal stages, nitrogen gas remains constant. Nitrogen in Algae Bioreactors is from urea or other animal wastes. Nitrogen element mass is recycled via digestion of amino acids or other foods by animals and humans, yeasts, and bacteria, to urea and ammonia or similar then used by plants and algae to form amino acids in crops. The Hydroponic Stage atmosphere is assumed to be nitrogen poor, and fixation from the atmosphere in that stage is minimal. Any additional nitrogen in gas form that must be made is processed chemically using salts and nitrogen containing chemicals from animal wastes, though this is not an expected pathway for this analysis.
13. Crops (animal and plant) will be timed to allow continuous harvest, i.e. harvests every day to meet that day's needs. Harvest is assumed to be very efficient, so that harvest losses can be ignored. Storage is for up to a year if required. As a result periodicity aside from startup is not considered an issue. This means plants and animals will have a continuous set of immature biomass that will replace daily harvest. In the event daily harvest is impossible, storage is assumed to buffer crop harvest to allow continuous availability.
14. Spices are assumed to grow in habitat in some degree.
15. The human diet is averaged to be 2000 kcal, to meet minimums of the United States Recommended Daily Allowance (US RDA) guidance. Increases in population will be offset by resupply.
16. Nitrogen is a proxy for protein flows. It is assumed animals can digest and convert proteins and amino acids as long as basic components of the biochemicals are consumed.

It is assumed that in early stages of a settlement (assumed to be 100 people at start), the human population would be able to subsist on the early outputs of bioreactors, including algae and yeasts (Settlement Stage 0). Long term however, even with food assembly from printers using reactor outputs, the humans will need a wider spectrum of possible menus and types and the ability to supply restaurants and other settlements. This paper illustrates many key principles for this future.

III. Method

A. Starting Equations

Living biomass is hydrated with water, with wet to dry ratio, d , or expressed as biomass plus a mass of water such that:

$$L = d * B \text{ or } l = d * b \text{ or } L = B + W \text{ or } l = b + w \quad (1)$$

As a result a crop has contained water, and dry biomass for each crop harvested, or of the species alive in the stage.

B. Master Mass Flow Equation for a Stage

The master mass flow equations are similar to Eq. (1) and (2) in prior work⁰.

$$b_i + w_i + o_i + c_i = b_o + w_o + o_o + c_o \text{ averaged per living kg} \quad (2)$$

$$B_i + W_i + O_i + C_i = B_o + W_o + O_o + C_o \text{ for the whole stage} \quad (3)$$

The dry biomass (B for the stage, b averaged for each living kilogram of mass) is a complex mix of biochemicals, tracked by element, though shifting in compounds between input and output as each biological entity in the farm is a chemical processor. Adding in the components of biomass, we have the following master equations:

$$b_i + w_i + o_i + c_i = b_{o,g,edible} + b_{o,g,inedible} + b_{o,excreted} + w_o + o_o + c_o \text{ averaged per living kg.} \quad (4)$$

$$B_i + W_i + O_i + C_i = B_{o,g,edible} + B_{o,g,inedible} + B_{o,excreted} + W_o + O_o + C_o \text{ for the whole stage} \quad (5)$$

The following equations describe the mass flows for the stage types. Section D. below explains the reasoning for the edible and inedible components in each stage. For three stage types, these equations reduce to:

Algae Reactor:

$$b_i + w_i + c_i = b_{o,g,edible} + w_o + o_o \text{ averaged per living kg.} \quad (6)$$

Hydroponic Stage:

$$b_i + w_i + c_i = b_{o,g,edible} + b_{o,g,inedible} + w_o + o_o \text{ averaged per living kg.} \quad (7)$$

Aquatic Stage:

$$b_i + w_i + o_i = b_{o,g,edible} + b_{o,excreted} + w_o + c_o \text{ averaged per living kg.} \quad (8)$$

The Yeast-Bacteria Reactor is more complex, and retains the general equation overall, though in many scenarios, it also can be reduced:

$$b_i + w_i + o_i = b_{o,g,edible} + b_{o,excreted} + w_o + c_o \text{ averaged per living kg.} \quad (9)$$

It should be noted that the excreted biomass here is suitable as nutrient biomass for all photosynthetic organisms. It should also be noted that as found in my previous work⁰, humans do not exhale enough carbon dioxide to feed themselves.

C. Growth and Harvest

Due to the continuous harvest assumption, the total living biomass of the species must include animals/ plants that are to mature in the future, from seed (embryo) levels to one day short of harvest. If for example it takes 100 days

(T_{harvest}) for growth from seed to harvested plant, the living biomass to generate one day's food must use a multiplier, that includes a fractional amount for back-up (overgrowth), and also has a fraction (a growth multiplier) since the mass flow of the immature plants goes from zero to the full amount. Further mortality before harvest, requires some overgrowth to compensate. All these factors are summed into a population growth multiplier, Q , which is multiplied by time to harvest to increase the living biomass of the harvested crop, L_{crop} , as in Eq. (10) and Eq. (11).

$$L_{\text{tot}} = L_{\text{crop}} * (T_{\text{harvest}} * Q) \tag{10}$$

$$\text{or} \\ L_{\text{tot}} / L_{\text{crop}} = (T_{\text{harvest}} * Q) \tag{11}$$

Each species can follow a variety of growth models. A linear model assumes a constant added amount to living biomass per day, to get to the full crop mass at maturity (L_{crop}) from a very small seed (near 0) mass. Linear growth is not usually representative of reality. An exponential model, however, does capture the realistic mass additions for many organisms. For example, a fish grows with each mass portion adding a mass portion, so the more mass, the more mass is added. Another model, called 'sloped' here, assumes the crop organisms reach near-maturity early, but allow time for fruits (especially legumes and grains) to mature.

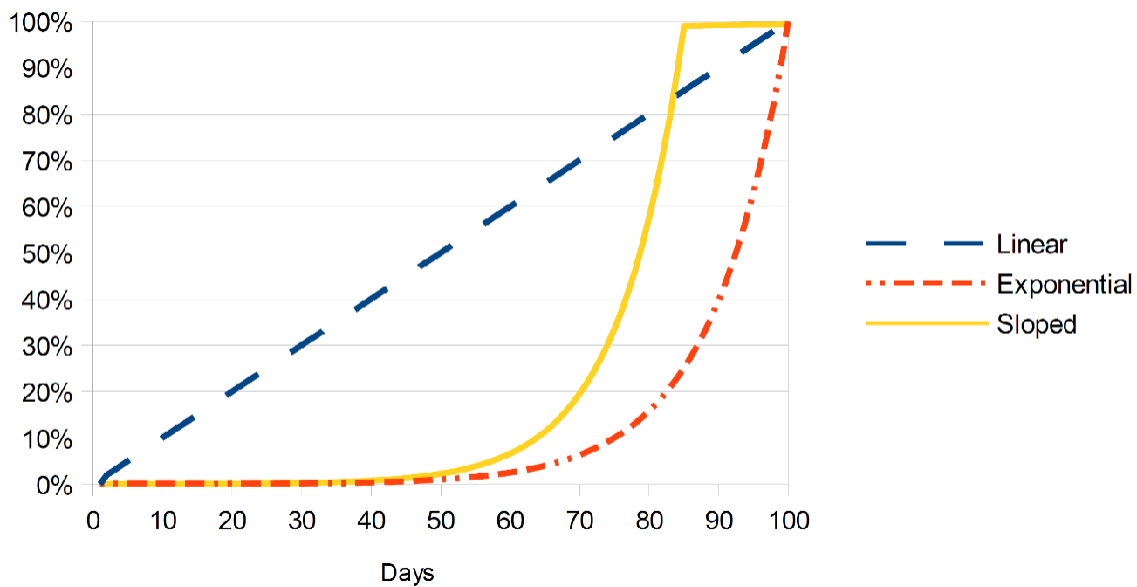

Figure 1. Three growth models for crops. Each crop has a different mass accumulation path from seed/egg (0 %) to harvestable organism (i.e. 100%).

Given these three growth models, the multiplier is the area under each graph, divided by the harvest time, and results in a multiplier of loosely 0.50 for the linear case, 0.11 for the exponential case, and 0.25 for the sloped case, assuming complete organism harvest each day. In this 100 day example, using the linear case, 2% of the mass is harvested, and 98% remains, while using the sloped model, 4% of the mass of the stage is harvested each day, 96% remains. Assuming an exponential growth, 9% is harvested, 91% remains, see Fig. 2. In essence, the portion of species that is not crop biomass is an inefficiency, represented loosely by the $(T_{harvest} * Q)$ term.

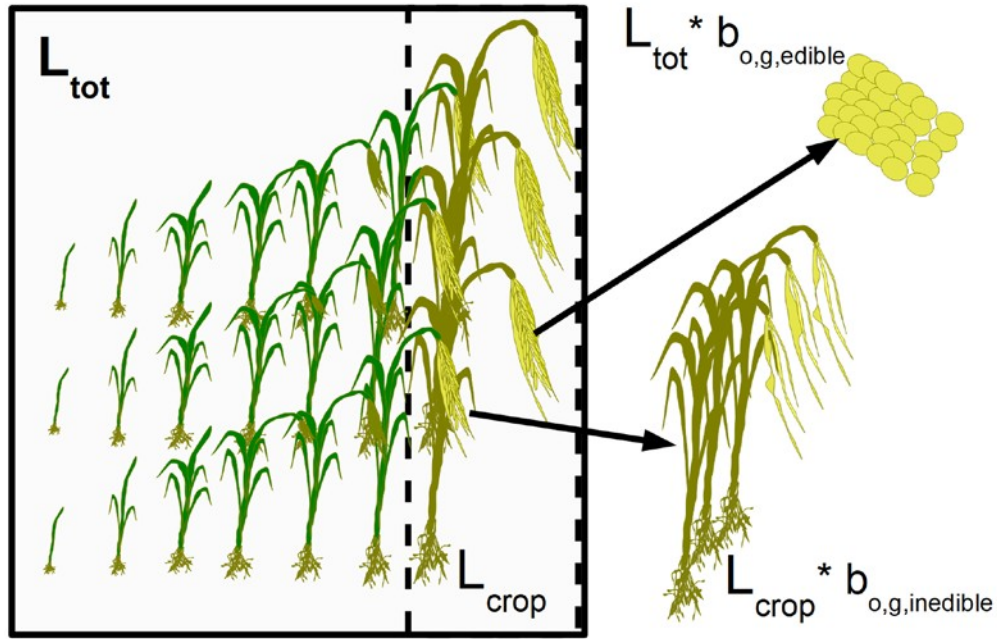

Figure 2. Relationship of total living mass to crop living mass and edible biomass.

For some plants however, like fruit trees and tomato plants, the growth model is different. Only excess inedible mass (leaves, branches pruned) and mature fruits (edible) are harvested, similar to the biomass in excretions of an animal. In this case harvest time may be longer from seed, but the mature plant remains alive. In this case, harvest time is daily as fruits mature, making for a very small $(T_{harvest} * Q)$. As a result, the model builds a virtual $T_{harvest}$ and Q to account for the growth dynamics and need for a small reserve of plants.

Animals (Fish, Shrimp, and Mollusks) follow a similar dynamic to the soybean example, since the entire crop organism is harvested, but with straight exponential growth, and an overgrowth that includes a breeder population that has individuals much larger and older than the crop. For many species of shrimp and fish, breeders are twice as massive as the crop, though very small in number (less than 1% to 0.1% of a large population of fish or for shrimp, represented by fecundity of the particular species, and brooding behavior). There is also mortality of organisms, ideally added to Q , <1% by population count, but insignificant by total mass, that die before maturity, reflected as inedible biomass output. This mortality should consider the fact that mortality mostly occurs when the mass of each organism is exceedingly small. All this results in overgrowth of roughly 1% for fish or shrimp, derived from references, and added to exponential multipliers.

For algae, bacteria, and yeasts, the doubling rate affects the mass in the stage (i.e. total living biomass). Living mass literally doubles on the order of a few hours to days, and continuous harvest includes the entire growth mass beyond that confined to the growth membranes. For the purposes of each farm here, productivity is time for the mass in the bioreactor to double in days, assuming full use. A small backup culture of minimal mass is maintained to restock the reactors, though insignificant when compared to mass and volume of the stage. As a result the $(T_{harvest} * Q)$ term is essentially the doubling time plus one.

D. Biomass and Edibility

A plant has its live mass divided into three portions: human edible, human inedible by edible by other animals (including fish and shrimp), and fully inedible. See the figure below. It is assumed roots are embedded in the hydroponic media of the hydroponic stage, while the remainder is in the aerial portion of the hydroponic stage. Roots are pulled and processed as human inedible for all but root crops. Inoculated fungi and bacteria in the media are largely constant, their biomass fed by nutrient liquids which contain a small amount of bacteria and fungi edible wastes in addition to plant nutrients and oxygen. When a root is removed, it is also assumed that while some bacteria and fungi are removed, some root capillaries may remain, which can be digested by the bacteria and fungi. The net result for this paper is a zero mass sum for bacteria and fungi mass for analysis purposes.

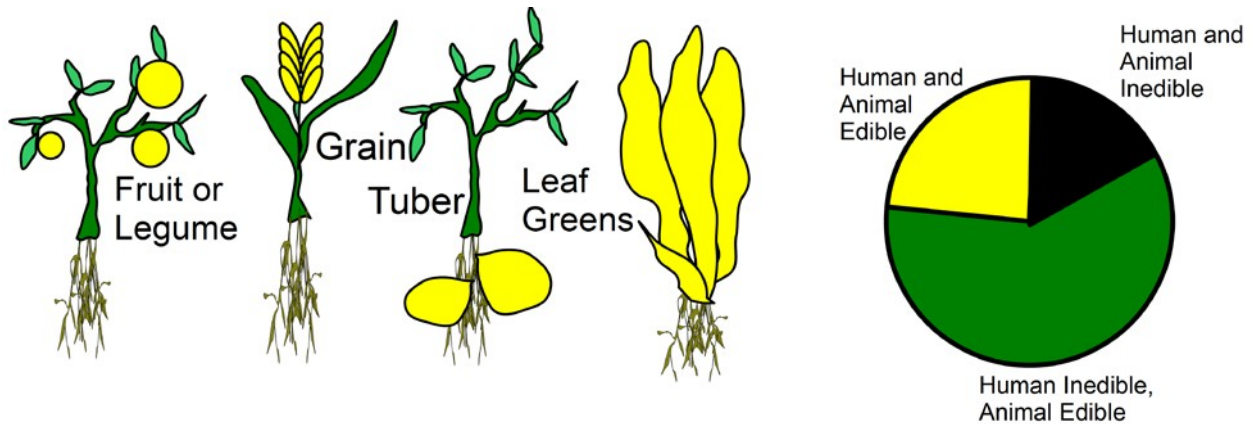

Figure 3. Edible and inedible portions of plants.

Given these mass fractions, the fractions for element breakout are found by using chemical formulas for carbohydrates, averaged lipids, amino acids, cellulose for fiber, and minerals as known. To simplify calculation, it is assumed that the inedible portions of the plant are always animal edible. Since the farm has a mass balancing system, inedible mass overall would be cycled into the Yeast-Bacteria Reactor to convert it to animal edible, so this is a valid simplification, if the flow is tracked to size the Yeast-Bacteria Reactor.

For algae in the Algae Reactors, there are no roots, and the algae cells are bound to a membrane immersed in nutrient and gas rich water. Pulsing pumps harvest essentially all growth (in new cells), and the entire mass extracted is edible by humans and all animals (due to selection of species and cultures).

In the case of animals, the entire organism is not necessarily edible directly without processing (i.e. fine grinding), but after treatment is assumed fully edible to take advantage of minerals and simplify calculations. As a food, aquatic animals produce primarily proteins and fats in dense form. In many cases the organism produces a percentage of desirable mass in meats, and a second source in meal. If there are no sources that allow computation of average dietary amounts for the whole animal, the meat portion nutrition data is used for the entire animal.

As stated above, the aggregate of the biomass of the entire stage for each species is used to find inputs and outputs for the species in the stage as a whole.

E. Species Used

The twelve species (plus yeast) used in this paper are listed with sources for metabolism and nutrition in Table 2. Several hydroponic species were selected based on data availability, ease of hydroponic growth, and palatability. Potatoes were selected due to numerous requests in previous presentations. Three animals were also selected, based on the ability to directly consume algae and wastes, tolerance for high density farming, swift growth, and availability of data. The combination of these species should provide a diverse menu. In addition to the plants and animals, cyanobacteria (Spirulina) and green algae (Chlorella) were selected for the Algae Reactors. Green algae are fast reproducers, and very swift carbon dioxide to oxygen converters, and Chlorella is commonly consumed on Earth in probiotic drinks. Spirulina is also commonly consumed in pill or drink form, is a slower photosynthetic crop, but very high in human nutrients. Since the Yeast-Bacteria Reactor has many functions, it has many species, though may be required to make yeast food products in early colonies or in emergencies. Therefore Baker's Yeast was used as a nutrient analog for yeast products from the Yeast-Bacteria Reactor.

Table 2. Crop species used, references, and assumptions. See the References section for each source cited here.

SPECIES	Scientific Name	Dietary Source	Metabolic Sources	Assumptions
Barley	<i>Hordeum vulgare</i>	USDA NDD #20004 ⁷	38	Field rates used.
Bell Peppers	<i>Capsicum annuum</i>	USDA NDD #11951 ⁷	39,40	Green house rates used.
Pinto Beans	<i>Chlorella sp.</i>	USDA NDD #16042 ⁷	36	Efficiency is equal or greater than field production, entire plant is harvested, including roots. Nitrogen is similar in overall plant.
Potatoes	<i>Phaseolus vulgaris</i>	USDA NDD #11352 ⁷	41,42	Personal observations used for volumes. Entire plant harvested.
Rice	<i>Solanum tuberosum</i>	USDA NDD #20088 ⁷	8,9,10,11,12	Efficiency is equal or greater than field production, entire plant is harvested, including roots.
Soy-beans	<i>Oryza sp. (hybrids)</i>	USDA NDD #11450 ⁷	13,14,15	Efficiency is equal or greater than field production, entire plant is harvested, including roots.
Tomato	<i>Solanum lycopersicum (hybrids)</i>	USDA NDD #11529 ⁷	1,24,25,26	Plants are picked for fruit, and trimmed to stay the same size continuously
Chlorella	<i>Chlorella sp.</i>	31	11, 28,29,30,31,32	Edible biomass by humans or animals
Spirulina	<i>Spirulina indica</i>	USDA NDD #11666 ⁷	22	Edible biomass by humans or animals
Shrimp	<i>Litopenaeus sp. Or Macrobrachium sp.</i>	USDA NDD #15270 ⁷	19,20,21	Entire mature organism is consumed. Breeders and small juveniles are a very small mass relative to crop. Crop is staggered to allow continuous harvest and replacement.
Silver Carp	<i>Hypophthalmichthys molitrix</i>	USDA NDD #15008 ⁷	16	Entire mature organism is consumed. Breeders and small juveniles are a very small mass relative to crop. Crop is staggered to allow continuous harvest and replacement.
Tilapia	<i>Oreochromis sp.</i>	USDA NDD #15261 ⁷	17,18	Entire mature organism is consumed. Breeders and small juveniles are a very small mass relative to crop. Crop is staggered to allow continuous harvest and replacement.
Yeast-Bacteria Reactor	Many, used <i>Saccharomyces cerevisiae</i> for food nutrition	USDA NDD #18375 ⁷	27,37	Edible biomass only produced as needed if the system is lacking biomass. Baker's Yeast used for nutrition. Yeasts and bacteria can digest proteins and nitrogen containing wastes to produce nutrients for plants.

F. Farm Stage Type Descriptions

Below is a description of each of the four farm stage types. For each stage type, each species is isolated in the conditions appropriate for it, with tanks, pumps, and other machinery to maintain and control growth to allow a daily harvest. As stated before each stage only takes in what it needs, and releases any crop and excess. In each stage conditions and assumptions are discussed below, with notional diagrams, as is the impact of the total mass and volume equations:

$$\text{Total Stage Mass in kg} = M * L_{tot} \quad (12)$$

$$\text{Total Stage Water Mass in kg} = M_w * L_{tot} \quad (13)$$

$$\text{Total Stage Volume in m}^3 = V * L_{tot} \quad (14)$$

M is the Mass Multiplier for the stage, which includes machinery and structures for that stage, as a multiple of the living mass of organisms in the stage. V is the volume multiplier for the stage, as a multiple of the living mass of organisms in the stage. Each equation has a term to account for flow variation between stages, in that tanks are required to hold the equivalent mass of volume of a day's inputs (though the tanks may be split for inputs and outputs, the sum is still one day's inputs). In Table 3 are the values used for each species in the farms in this paper.

Table 3. Volume and mass multipliers. Each multiplier is used with L_{tot} to find the size of each stage for each species. For example for barley, the total living biomass of all barley plants is multiplied by 3.7 to get the volume in cubic meters for the Barley Hydroponic Stage, by M to get the total mass of the Barley Hydroponic Stage, and M_w to find the mass of water in the Barley Hydroponic Stage.

common name	stage	V (Volume multiplier in m ³ per kg total stage)	M (Mass Multiplier per kg total stage)	M _w (Mass multiplier for water in stage)
Barley	Hydroponic	3.7	1.23	0.11
Bell Peppers	Hydroponic	0.34	1.11	0.01
Chlorella	Algae Reactor	5.39	6.23	4.5
Pinto Beans	Hydroponic	0.96	1.19	0.07
Potatoes	Hydroponic	0.29	1.13	0.03
Rice	Hydroponic	2.79	1.29	0.16
Shrimp	Aquatic	0.22	154.13	105.28
Silver Carp	Aquatic	0.04	30.47	20
Soybeans	Hydroponic	1.66	1.27	0.13
Spirulina	Algae Reactor	5.39	5.39	3.85
Tilapia	Aquatic	0.08	59.6	40
Tomato	Hydroponic	1.08	1.37	0.22
Yeast-Bacteria Reactor (in terms of mass processed)	Yeast-Bacteria Reactor	2.73	6.23	4.5

1. Hydroponic Stage Type

The Hydroponic Stages consist of vascular plant species, with roots in a container (troughs or tubes, though other spaces are possible) of water permeable media and the aerial portion (leaves, stems, etc.) in a light rich, sealed

container, with scaffolds to support fruit and vegetable bearing plants, and artificial light in the optimized in the red/blue spectrum both above and around the plants as in Fig. 4.

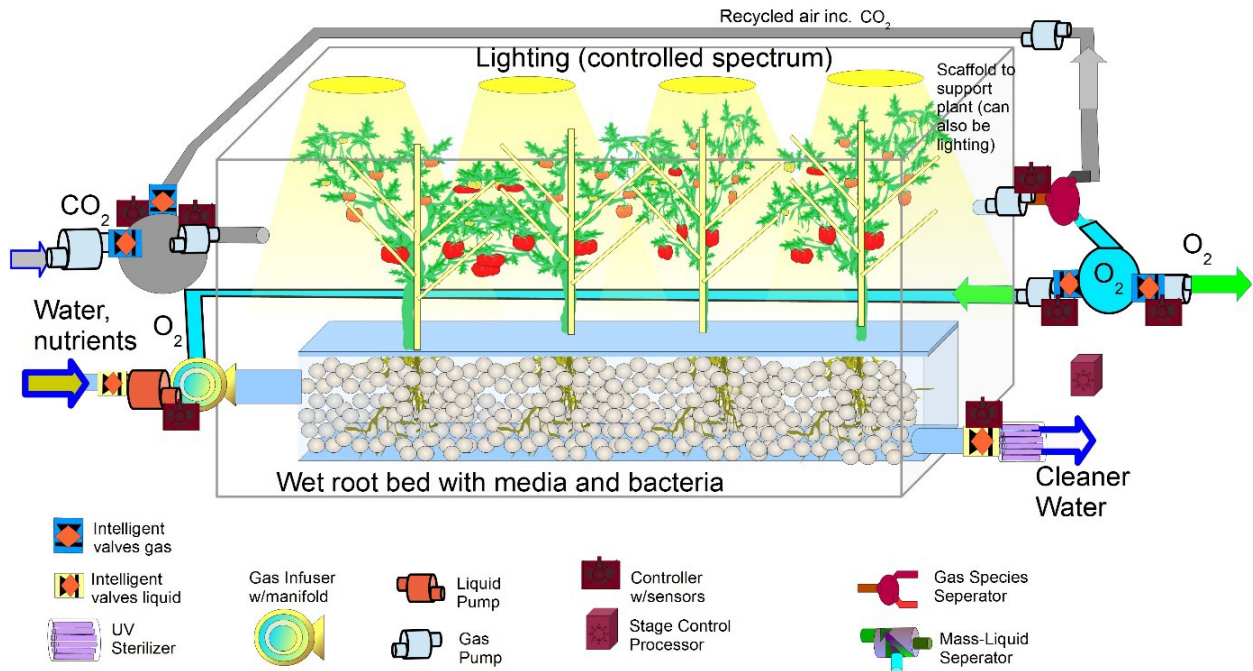

Figure 4. A notional depiction of a tomato hydroponic stage and components.

The root media can consist of a variety of media as appropriate for the plant, but is typically gravel, or hollow shapes, or fiber, and inoculated with root fungi and bacteria. Inoculation is critical to assure nutrient uptake by the roots, at the cost of added oxygenation of the water in the root bed. The water flowing through the root bed enters rich in both nutrients and oxygen, and exits minus oxygen, but also minus most of the nutrients, leading to purer water. The nutrients are a form of inedible biomass, typically excreted from humans or aquatic animals as urea or ammonia, though can also be concentrated from the digestion of wastes in the Yeast-Bacteria Reactor. Water will be oxygenated from the gas products of the aerial portion, reducing the net oxygen output of the stage, but increasing growth rate and gaseous carbon and liquid nitrates fixation. The nitrogen source for all plants is assumed to come from nutrient biomass supplied in liquids to the root bed, not fixed from the atmosphere as on Earth. Liquids are circulated to the root beds from a buffer tank (part of the grey and black water farm circulation system), and a clean water tank accepts clean water removed via membrane filter, recirculating remaining nutrients to the buffer tank.

Large in gas volume, the aerial portion will be rich in carbon dioxide (CO_2), and kept at the optimal partial pressure with inert gases, balance by recirculating pumps, gas separators, and a complex array of sensors and controllers. Excess oxygen is fed to the gas distribution system for use in either the Aquatic Stages or Habitat, while carbon dioxide is supplied to the farm from a tank, which is in-turn supplied from the aerobic stages such as the Habitat, Aquatic Stages, and Yeast-Bacteria Reactor via the gas distribution system. Harvest and trimming of the aerial portion will be continuous, with some plants in various levels of growth from seedling to harvest. As one set is harvested, the next set is timed to replace the harvested amount in the next harvest cycle (i.e. daily). Robots or humans with masks could perform harvest and maintenance, though due to spacing, robots may be preferable. Adding human walking space would add a footprint penalty for many species. On Earth, vegetable crops are spaced to allow human access, but in grain crops and soybeans plants are so close that only vehicles can access and harvest the crops. In the Hydroponic Stage gardens, the spacing will be a trade-off decision based on need for human access to the root bed troughs and aerial portions.

In the Hydroponic Stages, the oxygen for ripening of fruit is assumed to be small, as is oxygen injection to the roots and associated bacterial/fungal community in the hydroponic media, though computed and subtracted from photosynthetic oxygen production when data is available, at the per living biomass level. In this concept, the stage machinery would extract a small fraction of oxygen produced and inject it to the roots or keep it in the optimal partial pressure so that the net sum is seen from the stage as a whole for that species and living biomass. This results in an aggregate biochemical model for the mass flow for each living kilogram of the species, which is multiplied by the total.

In overall mass balance (or productivity terms), the Hydroponic Stage intakes water, carbon dioxide, and biomass in the form of nitrogen rich nutrients, then produce inedible (excess growth) and edible biomass (crop), and oxygen. The excess growth includes growth in pre-harvest plants, or plants that survive multiple harvests (as in tomatoes or fruit trees). Harvest of some plants will result in removal of the whole plant and roots, as for grains, potatoes, carrots, etc. Inedible harvested portions are cycled as required to either the Yeast-Bacteria Reactor, or in some cases, ground up and fed to aquatic organisms. Edible portions are processed for human food, or in the case of excess, fed to aquatic organisms, or if the farm is carbon-dioxide poor, digested by the Yeast-Bacteria Reactor.

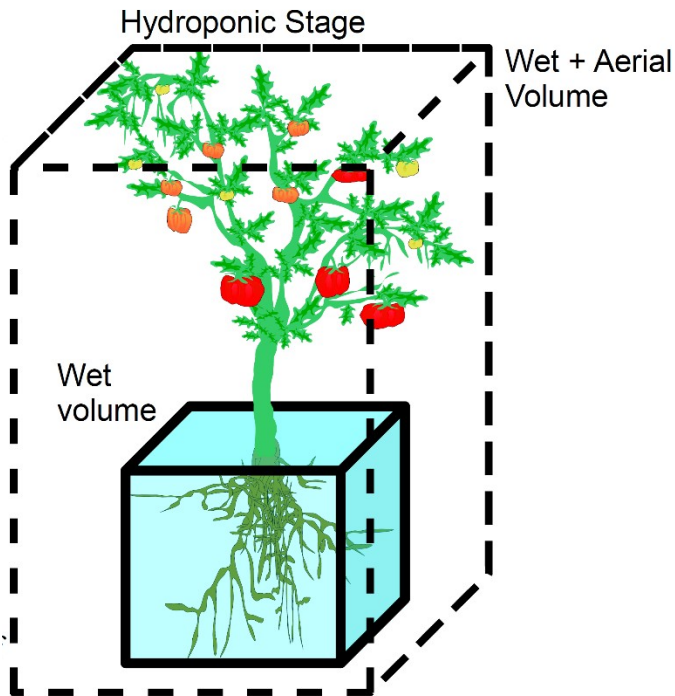

Figure 5. Division of volumes for hydroponic plants.

Overall stage mass is a multiplier of living biomass in the stage ($M * L_{tot}$), plus a day's inputs in tanks (sum of $C_i + W_i + B_i$). Mass sizing multiplier (M) of the farm includes the plants themselves, including seedlings and seed, plus the mass of media, bacteria, fungi, and water, the mass of lighting and supports, and mass of root bed walls, aerial container, pumps, tanks, pipes, and structure, with water in the liquid circulating pipes. Water is assumed to be the liquid mass, and the living biomass of plants is tracked as well. Water mass (M_w) contained in the Hydroponic Stage is tracked specifically, as it is part of the total farm mass, and must be supplied from another location or provided using in-situ resources. The tank size for each stage will be one day's input to assure a supply for the plants. The root media is assumed to reduce the mass of the volume of the root bed from what a straight water root bed would be. This work assumes media occupies at least 50% of volume in the root bed, reducing the mass of root bed. Walls are assumed very thin in all cases, and pumps are small in comparison to filled tanks. For all

the machinery, controls, lights, and pipes, assume an extra 10%.

Volume and footprint are similar in concern to mass. Living biomass is assumed to occupy a volume of aerial and root bed, with added ratios for piping, and machinery, and added space for either human or robot workers. Plant sizes in this paper are assumed to be similar to field volumes as observed by author, or available from references herein, then scaled to calculate for living biomass in kg. Ratios for pipes, excess spacing, and other factors are then added as a multiple, and tanks for liquids added assuming standard liquid (water) volumes. In short, a series of multipliers based on total living biomass is used to get total stage volume (i.e. $V * L_{tot}$). Footprint also assumes staking, which is unlike an open field, but reflective of industrial hydroponic operations on Earth. If a Hydroponic Stage is required in the farm to produce a large portion of calories for human consumption or export, the footprint will be the largest portion of the farm as seen in my work to date.

As a food, plant crops produce dietary fiber (cellulose, a carbohydrate), fats, and digestible carbohydrates, with some proteins especially from beans. The leaves, stems, and roots are inedible biomass, and are largely water and fiber, with some portion of edible carbohydrates and fats, minerals, and some nitrogen-rich proteins. Rice straw for example can be used to make tea, though here that use is ignored.

In the very long term, the hydroponic stages could be supplemented or replaced by in soil plantings.

2. Aquatic Stage Type

The Aquatic Stages consist of a series of raceway tanks (i.e. tanks that accept water at one end and remove it to the opposite end, similar to a stream) that hold aquatic animals including fish, shrimp, or mollusks. Some mollusks

can be raised together with fish, though it is assumed each tank in this paper is mono-specific. Water in the tanks is recirculated, after removal of excreted biomass and excess carbon dioxide. The raceway may be substituted by cylindrical tanks that have a whirlpool circulation pattern for some high speed swimmers and breeders. The aerial environment above the tank is minimal, as a trade off in size to allow human or robot access. Circulation of gases in the aerial portion removes excess water via condensers to return to the raceways or passed to other stages. In zero gravity environments, the aerial portion will be absent, and cues of current and light will point animals in the up-current, light up, direction. At the up-current side, food for the animals is injected. This food may be in the form of inedible biomass, cycled through the Yeast-Bacteria Reactor, or directly injected after sterilization and maceration, or edible biomass from excess hydroponic crops, other aquatic crops, Algae Reactor crops, or the Yeast-Bacteria Reactor. Shrimp and other crustaceans may require cages (of food grade mesh) to capitalize on the volume of the raceway. A similar arrangement for bivalves or other invertebrates could be used. Raceways or other types of tanks will be required to hold not just the crop of each species, but will also have separate tanks for the pre-crop juveniles, and for the breeders. The stages will be supplied by tanks for clean water, oxygen and clean biomass. Removal of excreted biomass is by both coarse filters and membrane filters, and pumps maintain pressure and velocity to the tank, while sensors, valves, pumps, and controllers add oxygen and maintain ion, pH, and inert gas concentrations in the water for the animals. Feeders add food mass on timers, and lighting provides both orientation and daily cycle timing for the fish. See Fig. 6 below for a notional depiction of a section of the stage.

For the Aquatic Stage, the net mass balance has inputs of biomass, water, and oxygen, as for aerobic metabolism and inflation of growth, and outputs of biomass and carbon dioxide. Biomass inputs can be of excess edible biomass, or processed inedible biomass. Biomass outputs are inedible growth in pre-harvest juveniles and breeders, edible growth from the harvested crop of whole animals, and excreted biomass (feces, urine). Excreted biomass, especially liquids, can be sterilized then provided to the root beds of the Hydroponic Stages, or to the Algae Reactors. Solids can be processed through the Yeast-Bacteria Stage to either become nutrient biomass for the Algae or Plants, or digested almost in total (minus ash), to provide carbon dioxide, or in a combination as required to balance the farm's biomass. Processing waste of the crop is assumed to be minimal (i.e. ground into meal), though could also be fed to the Yeast-Bacteria Reactor.

Overall Stage mass is a multiplier (M) of living biomass in the stage, plus a day's inputs in tanks (sum of $O_i + B_i + W_i$). For each living kilogram total in the stage, this paper uses 1/9 to 1/50 cubic meters of water and live animal. This may be overly pessimistic for some fish, crustaceans or mollusks, but is still useful for this paper. A tank of some thickness, and five walls of the stretched cube will add further mass, of a much denser material than water. Assuming a meter depth as a safety factor, the walls if made of a very strong ceramic or polymer would need to be a centimeter thick at least. Leaving out the end walls, the sides and bottom have a volume of roughly 300 cubic centimeters of material that is at least 33% denser than water, or roughly 0.4 kg per living kg. A rough factor will need to be added for pumps, pipes, and other machinery, assumed to be roughly 0.05 kg per living kg.

Volume and footprint calculation is similar to that for the Hydroponic Stages, volume a multiplier (V) of living biomass, plus a small volume for the tanks (sum of W_i and B_i , volume as for room temperature water). The multiplier should assume a ratio that considers the need for servicing of the tanks and room for pipes and machinery. Overall, a ratio of two times the raceway volume for total size, plus tank volume (i.e. a liter per kg of contained water, assuming gas tanks are very small), is similar to observation at hatcheries and space-constrained indoor farms. Assuming

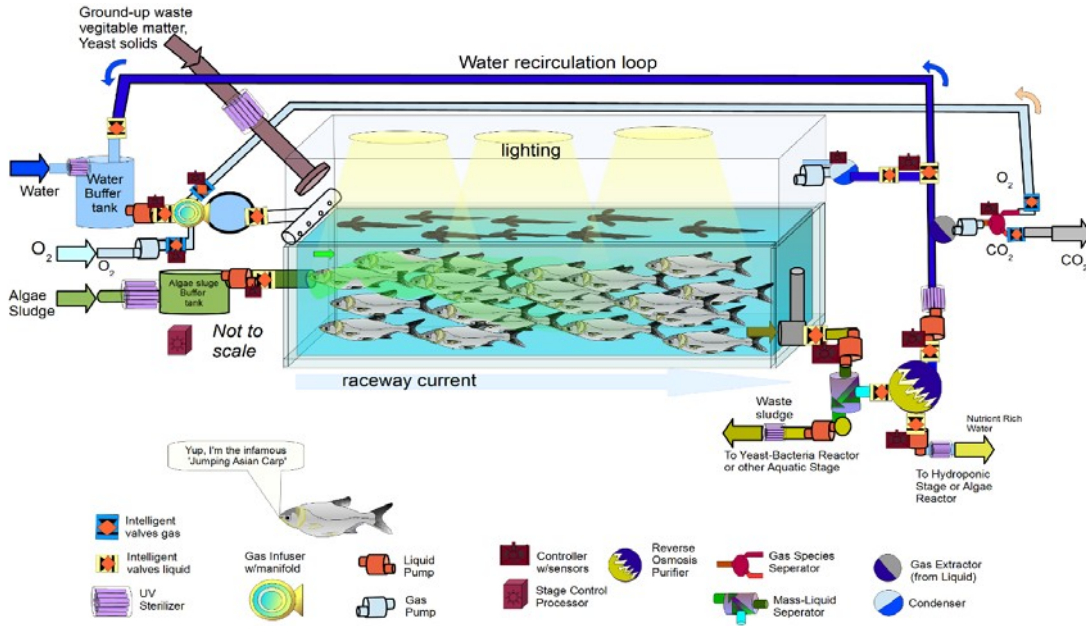

Figure 6. A notional depiction of a silver carp Hydroponic Stage.

stacking to 3m height, the footprint is rounded up from the volume divided by 3m in all Aquatic cases.

3. Algae Reactor Stage Type

The Algae Reactor design is a series of cylindrical tanks, with enclosed lights in strips and tubes, and with membranes to hold live algae and cyanobacteria (both called ‘algae’ herein for simplicity) cultures in scaffolding and membranes. The arrangement provides a very high production rate by providing a large lit surface area, with high extraction and supply of dissolved gases. The algae in the reactor are largely photosynthetic, and recycle carbon dioxide and nutrient biomass to produce oxygen and edible biomass in new cells (growth). All growth mass (beyond initial grow out) is in clumps extracted by pulsing pumps, and captured by a mass separator, then dried and stored for human consumption, or sterilized and compressed for aquatic animal feed. Any remaining excess is digested aerobically in the Yeast-Bacteria reactor to produce carbon dioxide as required to balance the farm. The algae contain a high ratio of water to dry biomass. Algae are also very efficient feed for aquatic species selected for the farm, as they are chosen because they eat algae in the wild or in aquaculture. Complex controls and sensors assure the algae are kept at ideal chemical, lighting, and temperature conditions (note: as assumed for all stages). It should also be assumed that the reactors will likely have to be produced on Earth or somewhere with complex manufacturing, then shipped empty to the farm in parts and assembled. See Fig. 7 for a notional depiction.

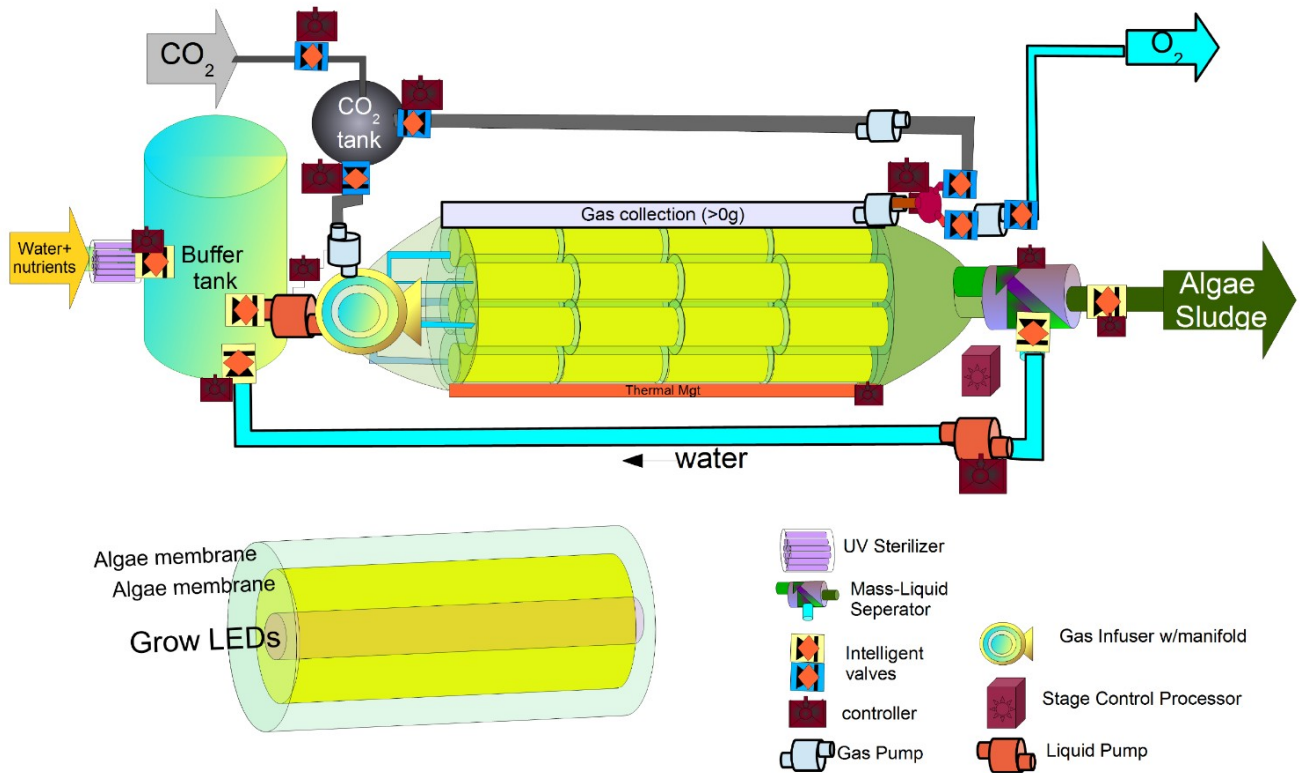

Figure 7. Notional depiction of an Algae Reactor stage.

In net mass balance, the Algae Reactor intakes carbon dioxide, water, and biomass (nutrients, rich in nitrogen) and outputs oxygen, and biomass in living growth, and water in the living growth biomass. The photosynthetic model is similar to plants, in that growth takes carbon from carbon dioxide to produce carbohydrates then other chemicals, releasing oxygen. The carbon input mass and water is in ratio to living biomass contained in the reactor. Since algae are unicellular microorganisms, this input ratio is tied to doubling rate.

In total mass, the reactor is sized as a multiplier of living biomass. In addition to being sized for pre-harvest mass and backup, the reactor will need to be sized to account, in early settlement levels, for a missing hydroponic stage to produce oxygen, and foods. The lighting is assumed to be similar in density to glass, though very small in volume and thus ignored, and membranes are likewise assumed to be very small in dry mass. This leaves the living biomass itself and surrounding solution, which mass-wise is assumed to be as for water. Assuming a 4 mm depth skim of living biomass (2mm on each side of a membrane), with a 1 cm of water and material, and assuming a near-water density of 1 (unless specified in references for the species), 1 kg of living biomass has roughly 1.1 liters of volume, with an additional volume of 2.5 liter of solution, or 3.6 kg total mass per living kg of biomass in reactor. Walls will need to contain the solution and biomass, plus mass for pumps and pipes, and mass for a day's worth of water, carbon dioxide and nutrients in a tank. The walls, pipes and pumps can be assumed to be a ratio of the contained mass, or roughly another 10% for this model.

Volume of the whole stage includes the volume calculations above to find total mass, but must also assume extra volume to allow maintenance of the Algae Reactor, as a percentage of the mass (assuming 1kg/liter), using an extra 50% in volume. This seems generous, but since the volume of the reactor is small in relation to the volume of the hydroponic and aquatic stages and since the volume likely includes an area to hold rescue cultures, and complex machinery, it is reasonable. Footprint can likewise be computed by assuming a height and dividing the volume. All these factors are adjusted further to arrive at V, M, and M_w multipliers.

4. *Yeast-Bacteria Reactor Stage*

The Yeast-Bacteria Reactor is a bioreactor similar to the Algae Reactor, though with multiple tanks, multiple membrane reactors, more complex sensors and controls, and an initial tank with loose bacteria and fungi in a controlled balance. Yeasts and bacteria in this bioreactor have to have a different environment than algae due to the nature of yeast and bacteria, which do not grow well in light, and have different chemical needs than algae. Overall, the reactor is similar to beer fermenters, reactions in soil fungi, and commercial compound production. The Yeast-Bacteria Reactor will at a minimum have to contain cellulose digesting tailored species (enzymes to hydrolyze fiber into fructose, likely from accelerated versions of soil bacteria, and fungi and bacteria used by carpenter ants and termites), or else the carbon in the system will accumulate in fiber. Each tank and reactor has a settling and mass separating stage, and each has pumps, infusers, removers, and thermal controls. Each module (there can be many) has membrane and scaffold confined yeasts (similar to bread or beer yeasts) and bacteria (tailored to produce various outputs). Solid and liquids can be extracted and sent onward, or recycled to other modules. If solids are produced to balance human available nutrition, the products are assumed to be similar in nutrients to bread yeasts. In previous work, all scenarios resulted in aerobic metabolism to balance carbon dioxide and water, with limited biomass production except as required when other stages are absent. As mentioned before, inedible biomasses and excreted biomass can be processed to balance nutrient or other biomass types, at the cost of a larger living biomass and ensuing bioreactor and tanks. See Fig. 8 below for a notional depiction.

As a net mass balance, the Yeast-Bacteria Reactor acts as the balancing stage for the rest of the farm, converting chemical compounds to consume and produce compounds for the rest of the farm, in most farm scenarios consuming biomass and oxygen to produce carbon dioxide and water aerobically (generating heat), however, other modules and set conditions can consume biomass to produce anaerobic products (such as alcohol) or to favor production of yeast edible biomass. All these may occur simultaneously. As a result the machinery is very complex.

Sizing for this reactor is the greatest of 1) the need to feed settlers in early stages of development, and 2) the flow and conversion mass of the entire farm, i.e. to convert inedible and excreted biomass into useful biomass, or aerobic consumption. As total mass for the stage, both operation to convert biomass into other types of biomass, and to aerobically process biomass and oxygen into carbon dioxide and water must be considered. Like the Algae Reactors, a skim of living cells in scaffold and membrane, or loose in the initial tank, is surrounded by a solution infused with dissolved gasses and biomolecules from biomass that is circulated. The solution to living biomass ratio is assumed for this model to be roughly 2 to 1, which is added to tanks and pipes together holding a day's worth of input mass that includes biomass conversions, with very thin walls.

The machinery is more complex than for the Algae Reactors, and like the Algae Reactors will most likely be built from parts assembled on Earth or similar complex industry locations. If the Yeast-Bacteria Reactor is replacing the needs for other stages, it may drive the size of the reactor even as other stages emerge, providing a capacity to produce emergency foods in the event of failures in other stages. As a result the Yeast-Bacteria Reactor, like the Algae Reactors, can be throttled to meet farm demands.

Total volume in the stage is reliant on a larger space need than the Algae Reactors, though the total Yeast-Bacteria Reactor Stage can be spread out and squeezed into various locations in the farm. Overall loosely a $1.5 \times$ total mass (where 1 liter/kg conversion is used) is used for V, and as in other stages, footprint is found by dividing a predicted height (3 meters) into the volume. Even in worst cases, when all stage types are present, prior work^{0,1} has shown that the Yeast-Bacteria Reactor stage is usually small in comparison to Hydroponic and Aquatic Stages together, though some solutions may deviate from this observation.

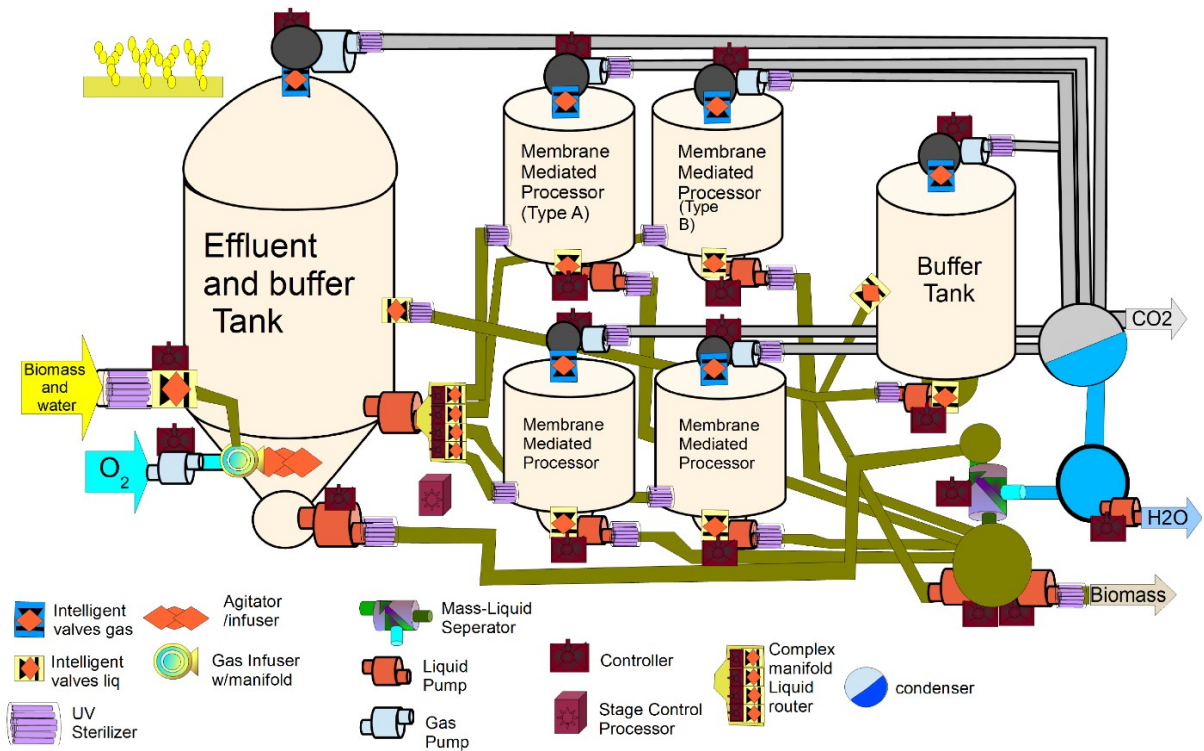

Figure 8. Notional depiction of the Yeast-Bacteria Reactor Stage.

5. Volumes and Masses for other Farm Systems

Other systems link the farm into a synergy, beyond what previous work has assumed, and these cost mass and volume, and can be calculated by allocating to each stage. A black water/grey water system will have an initial septic tank to receive human waste (at a day's worth of biomass excreted volume and mass) to pre-process these wastes before they enter the main Yeast-Bacteria Reactor. The septic tank and macerators liquefy solids (though given a small human population this tank could be omitted). There should also be a clean water system with pipes and a clean water tank to collect water from the farm, after using a sterilizer and final filter, to return to the Habitat. There will also be a 'mass system' with storage areas for excess crops and inedible products, and crop processing areas to prepare crops for culinary use. Likewise, a nutrient system will flow liquid excretion biomass and reactor digested liquids to the Hydroponic and Algae Reactor stages, then shunt clean water from the hydroponic stage to the clean water system. Drying biomass for storage will also send clean water to the clean water system. Together these are assumed to add 15% to total volume, with 1 days total in and out flow from the farm overall (i.e. to and from the Habitat), or roughly 6 kg as mass and 0.006 cubic meters volume per person, though this is the same for all scenarios, and added to each scenario's mass.

6. Human Habitat Model

Like a stage in the farm, the habitat is assumed to take in, and release, only what is needed or excess. This assumption means the habitat has internal methods for dealing with grey water from showers, washing, and adding and removing aerial water by dehumidifiers and humidifiers. Part of the grey water cycle is assumed to include the use of in-habitat plants including spices, which can be provided a grey water line and in the process of cleaning the water via filtering and transpiration, provide needed flavor to the diet, air processing, and color for psychological needs. The net effect of the in-habitat plantings is assumed from a mass perspective to be negligible for calculation. Given this table, the mass flow for the Habitat becomes similar to the Aquatic Stages, with notable exceptions (we don't eat people in the farm for one):

$$B_i + W_i + O_i = B_{o,excreted} + W_o + C_o \quad (15)$$

Table 4. Human Mass Flow Model. This table shows the inputs and outputs per person assumed for this paper. For example, at the Habitat level, averaged per person, the Habitat takes in 0.59 kg oxygen per person, 5 kg water, and 0.47 kg dry mass of foods (of which 0.44 kg, the part not fiber, is used in the body) totaling 2,000kcal.

Per person per day		%% by mass				kg mass			
Mass Component	Kg	C	O	H	N	C	O	H	N
Lipids +Cholesterol	0.0703	83.87%	4.14%	11.99%	0.00%	0.059	0.003	0.008	0
Carbohydrates	0.324	42.11%	51.41%	6.48%	0.00%	0.136	0.167	0.021	0
Cellulose (Fiber)	0.025	44.45%	49.34%	6.22%	0.00%	0.011	0.012	0.002	0
Proteins	0.05	45.58%	29.97%	7.32%	14.73%	0.023	0.015	0.004	0.007
NET Oxygen in**	0.59	0	100.00%	0	0	0	0.59	0	0
Water in*	5	0.00%	88.81%	11.19%	0.00%	0	4.441	0.559	0
NET INPUT	6.059					0.229	5.227	0.594	0.007
DIGESTABLE INPUT (-cellulose)	6.034					0.22	5.21	0.59	0.01
Dietary Calories (from total non-fiber biomass inputs)(in kilocalories or kcal)					2000				
Per person per day		%% by mass				kg mass			
Mass Component	kg/person/day	C	O	H	N	C	O	H	N
Excrete (Dry Biomass out)	0.034	24.22%	20.02%	32.96%	22.80%	0.008	0.006	0.011	0.007
Carbon Dioxide out	0.811	27.29%	72.71%	0.00%	0.00%	0.221	0.59	0	0
Water out	5.214	0.00%	88.81%	11.19%	0.00%	0	4.631	0.583	0
NET OUTPUT	6.059					0.229	5.227	0.594	0.007
* = Includes water in wet biomass from foods, assumes 3 liters drink , and 2 liters in food.									
** = NET Oxygen in is Oxygen in minus Oxygen out, stage aggregate.									

Under all scenarios, to allow comparison, the human population is assumed to be 100 grown adults of static weight. To deviate, the population just needs to average to the same consumption and intake as these 100. The mass flow in the habitat is a black box, and only gases, water, and foods needed enter, or excesses exit. It is assumed some vitamins can be synthesized in habitat if not present in foods, and that humans can synthesize or digest proteins. That said, people need a minimum amount of proteins, carbohydrates including fiber (cellulose), and fats, to be active and productive, as shown in Table 4.

Given these needs, the harvested mass of each species, as in Table 5, provides a different set of percentages in its mass, for each human nutrient, and the model used here considers this mix when assaying a farm solution's suitability in each scenario.

Table 5. Nutrient breakdown by farm crop. For example, 1 kg in wet mass of barley grain has 3,540 kcal, which is more than the 2,000 kcal requirement. Of this 1 kg, 56.18% (0.562 kg) is carbohydrates other than fiber.

Species	Nutrient Composition (kg) by living kg crop edible biomass						
	Kcal per kg	Carbohydrate**	Fats	Proteins	Fiber	N*	S*
Barley	3540	56.18%	2.30%	12.48%	17.30%	1.60%	0.12%
Bell Peppers	270	5.42%	0.21%	1.00%	0.90%	0.13%	0.01%
Chlorella	383	2.27%	0.91%	5.71%	0.03%	0.82%	0.06%
Pinto Beans	3470	47.05%	1.23%	21.42%	15.50%	2.92%	0.12%
Potatoes	770	15.46%	0.09%	2.05%	2.03%	0.26%	0.01%
Rice	3570	71.00%	1.02%	13.29%	5.88%	1.89%	0.13%
Shrimp	850	0.00%	0.51%	20.04%	0.00%	2.95%	0.48%
Silver Carp	1270	0.00%	5.57%	17.10%	0.00%	2.48%	0.16%
Soybeans	1470	6.85%	6.80%	12.95%	4.20%	1.80%	0.07%
Spirulina	260	2.02%	0.39%	5.99%	0.40%	0.89%	0.60%
Tilapia	960	0.00%	1.70%	19.87%	0.00%	2.86%	0.19%
Tomato	180	2.63%	0.20%	0.88%	1.26%	0.11%	0.00%
Yeast from Yeast- Bacteria Reactor	773.5	3.59%	1.91%	10.14%	6.74%	1.39%	0.08%
HUMAN NEED (kcal or kg)	2000	0.32	0.07	0.05	0.03	0.01	N/A

Assuming a single crop species could be used to meet each need above, the next table emerges in harvested crop mass to meet the human needs as shown in Table 6.

Table 6. Minimum mass of food for a single species to meet each human need. For each species, each value lists the living mass (wet edible biomass) required to meet the human need for each nutrient at the bottom. For example, 0.56 kg of barely grain meets the human caloric need).

species	minimum edible biomass (in kg raw food) to meet USRDA Minimums						Worst Case
	Kcal	Carbohydrate**	Fats	Proteins	Fiber	N*	
Barley	0.56	0.58	3.06	0.4	0.14	0.46	3.06
Bell Peppers	7.41	5.98	33.48	5	2.78	5.48	33.48
Chlorella	5.23	14.28	7.73	0.88	85.21	0.9	85.21
Pinto Beans	0.58	0.69	5.72	0.23	0.16	0.25	5.72
Potatoes	2.6	2.1	78.11	2.44	1.23	2.78	78.11
Rice	0.56	0.46	6.87	0.38	0.43	0.39	6.87
Shrimp	2.35	N/A	13.82	0.25	N/A	0.25	13.82
Silver Carp	1.57	N/A	1.26	0.29	N/A	0.3	1.57
Soybeans	1.36	4.73	1.03	0.39	0.6	0.41	4.73
Spirulina	7.69	16.04	18.03	0.83	6.25	0.83	18.03
Tilapia	2.08	N/A	4.14	0.25	N/A	0.26	4.14
Tomato	11.11	12.32	35.15	5.68	1.98	6.77	35.15
Yeast from Yeast-Bacteria Reactor	2.59	9.02	3.68	0.49	0.37	0.53	9.02
HUMAN NEED	2000	0.32	0.07	0.05	0.03	0.01	

G. Accounting Biomass for Pre-Harvest Organisms

To go from mass per living biomass per day, to a whole stage's mass per day, can be challenging. Once mass is harvested each day, the next day's biomass still remains, growing to be harvested the next day, with a day's harvest for each future day growing in the stage. Accounting for the yet to be harvested portion of biomass (and its consumed mass) remaining in the stage is a tricky proposition to retain balance. For example photosynthetic organisms use carbon dioxide, water and biomass in nutrient form, releasing oxygen, and providing biomass in growth in the crop harvested (with its carbon), but retaining carbon and water in the biomass of the yet to be harvested organisms. If the carbon is unaccounted, the farm's overall mass flow will remain unbalanced, as will that of the stage when taking a daily snapshot, i.e. mass in will not equal mass out. Accounting for this imbalance is critical for finding populations for a stable farm. Options include:

A. tracking the growth mass as crop produced in the future though realized now for balance calculations, but ignoring it for human nutrition needs, and

B. ignoring the consumption and production of the pre-harvest biomass for balance calculations, but adding in multipliers later to size the farm.

Option B is simpler to calculate, but can be either pessimistic or optimistic in sizing the farm, since it roughly guesses at the size of the pre-harvest biomass, and thusly adds guesses into the footprint post software. Even so, the estimate can be roughly accurate for feeding the habitat. This option is similar to the approach in my prior work^{0,1}.

Option A, however, treats the entire stage as a single living biomass, releasing only a percentage (L_{crop}/L_{tot}) for human use, and retaining the remainder in the farm system, balancing the human outputs to the farm, and treating each stage as a single entity. This is an accounting trick and creates a minor built-in error for flows from each stage, which then can be removed to size flow-based tanks and equipment (or left in to allow a margin of safety), but sizes the farm accurately to match total farm input and output within reason. See Fig.9.

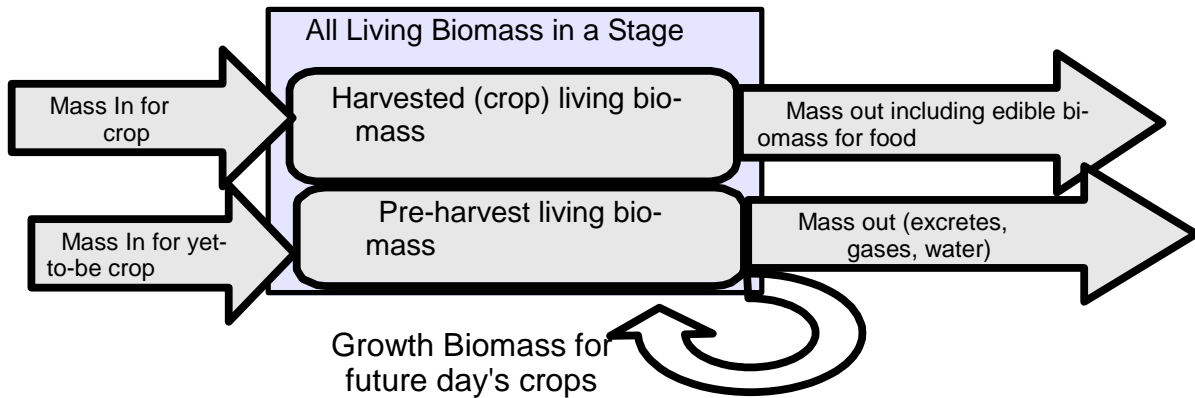

Figure 9. Mass flows for both the day's harvested crop, and the remaining living biomass.

Therefore, option A is the method used here. As a result, the per kg living biomass mass flow must be altered before input into the model software. As a result a multiplier (L_{tot}/L_{crop}) is applied to all masses, though the output biomass budget shifts. Inedible biomass includes the unrealized edible biomass (i.e. $(L_{tot}/L_{crop}) - 1$) providing the equation below:

$$(L_{tot}/L_{crop}) * b_o = [((L_{tot}/L_{crop}) * b_{o,g,inedible} + ((L_{tot}/L_{crop}) - 1) * b_{o,g,edible})] + b_{o,g,edible} + (L_{tot}/L_{crop}) * b_{o,excreted}$$

where inedible biomass is the $[((L_{tot}/L_{crop}) * b_{o,g,inedible} + ((L_{tot}/L_{crop}) - 1) * b_{o,g,edible})]$ term. (16)

Given the references, and calculations based on metabolism (Q) and harvest times ($T_{harvest}$) discussed earlier, the Table 7 shows the (L_{tot}/L_{crop}) ratios used for each species.

Table 7. Growth parameters used for crop species. Each species has a set of mass accumulation parameters (i.e. growth in wet biomass). Growth type is mostly one of the graphs from Figure 1.

Common name	Stage	Harvest time in days (T_{harvest})	Growth type	Q	$L_{\text{TOT}}/L_{\text{CROP}}$
Barley	Hydroponic	300	sloped	0.25	75
Bell Peppers	Hydroponic	189	exponential	0.11	20.79
Chlorella	Algae Reactor	0.33 doubling time, effective harvest 1.04 days	exponential	1.1	1.36
Pinto Beans	Hydroponic	94	sloped	0.25	23.5
Potatoes	Hydroponic	120	exponential	0.11	13.2
Rice	Hydroponic	120	sloped	0.25	30
Shrimp	Aquatic	120	exponential	0.11	13.2
Silver Carp	Aquatic	365	exponential	0.11	40.15
Soybeans	Hydroponic	150	Sloped	0.25	37.5
Spirulina	Algae Reactor	2.52 days doubling time, 3.64 effective days	exponential	1.1	4.00
Tilapia	Aquatic	150	exponential	0.11	16.5
Tomato	Hydroponic	49 days to first crop. Effective rate is 11.25 days	special (assumes perennial tomato trees)	1.1	1.1
Yeast-Bacteria Reactor	Yeast-Bacteria Reactor	0.333 day doubling rate, ~0.6 Effective Harvest days	exponential	1.1	2

H. Species Mass Flows

Given all the assumptions above, and added species for this paper, the following tables emerge as inputs into the later balancing model, listing all species considered in Table 8.

Table 8. Mass in kg per day consumed per living kg in stage per species total. For example, 1 kg of living barley plants in the Barley Hydroponic Stage use 0.290 kg carbon dioxide per day averaged for the whole Barley Hydroponic Stage.

Species	L _{tot} / L _{crop}	Inputs			Biomass in (total)
		CO ₂	H ₂ O	O ₂	
Barley	75	0.290	0.164	0.000	0.008
Bell Peppers	20.790	0.013	0.106	0.000	0.001
Chlorella	1.36	0.204	1.238	0.000	0.017
Pinto Beans	23.5	0.372	0.132	0.000	0.016
Potatoes	13.2	0.038	0.074	0.000	0.026
Rice	30	0.364	0.152	0.000	0.007
Shrimp	13.2	0.000	0.157	0.127	0.199
Silver Carp	40.15	0.000	0.084	0.154	0.179
Soybeans	37.5	0.691	0.784	0.000	0.091
Spirulina	4	0.162	1.041	0.000	0.017
Tilapia	16.5	0.000	0.078	0.024	1.650
Tomato	1.1	0.030	0.186	0.000	0.002
Yeast-Bacteria Reactor (Yeast Mode)	2	0.000	6.764	2.535	0.028

Table 9. Mass in kg per day produced per living kg in stage per species total. For example, 1 kg of living barley plants in the Barley Hydroponic Stage output 0.210 kg of oxygen per day.

species	L _{tot} / L _{crop}	Outputs			Biomass out (total)
		CO ₂	H ₂ O	O ₂	
Barley	75	0.000	0.060	0.210	0.190
Bell Peppers	20.790	0.000	0.101	0.010	0.009
Chlorella	1.36	0.000	1.189	0.148	0.122
Pinto Beans	23.5	0.000	0.046	0.270	0.204
Potatoes	13.2	0.000	0.087	0.028	0.023
Rice	30	0.000	0.018	0.272	0.233
Shrimp	13.2	0.174	0.157	0.000	0.151
Silver Carp	40.15	0.212	0.170	0.000	0.034
Soybeans	37.5	0.000	0.524	0.409	0.633
Spirulina	4	0.000	0.998	0.118	0.104
Tilapia	16.5	0.033	0.078	0.000	1.641
Tomato	1.1	0.000	0.174	0.024	0.021
Yeast-Bacteria Reactor (Yeast Mode)	2	3.486246	2.525850	0.000000	3.314764

Table 10. Biomass output breakdown by species for total living mass. For example, for 1kg of living biomass in shrimp (averaged for total living biomass in the stage including not yet harvested organisms) produces 0.0018 kg edible dry biomass per day, 0.0221 kg yet to be harvested or otherwise inedible dry biomass, and 0.1272 kg excreted dry biomass per day including urine and feces. Each row adds to the ‘Biomass out total’ number in Table 9.

species	Outputs		
	Biomass out edible	Biomass out inedible	Biomass out excretion
Barley	0.0013	0.1887	0.0000
Bell Peppers	0.0003	0.0085	0.0000
Chlorella	0.0897	0.0326	0.0000
Pinto Beans	0.0035	0.2004	0.0000
Potatoes	0.0012	0.0216	0.0000
Rice	0.0034	0.2295	0.0000
Shrimp	0.0018	0.0221	0.1272
Silver Carp	0.0007	0.0259	0.0080
Soybeans	0.0038	0.6292	0.0000
Spirulina	0.0259	0.0777	0.0000
Tilapia	0.0014	0.0213	1.6180
Tomato	0.0059	0.0148	0.0000
Yeast-Bacteria Reactor (Yeast Mode)	1.6574	1.6574	0.0000

Table 9 shows the ensuing outputs by species and the sum of biomass out. Given the Option A model, there is a division of the output biomass that lists both inedible biomass from the harvested crop, but also adds as inedible the edible and inedible biomass from the pre-harvest organisms. This division of biomass is shown in Table 10. The edible biomass in Table 10 is multiplied by the dry values of nutrition for each species (Table 5 values * 1/d for each species, $b_{o,g,edible}$ is a dry mass value) to get the minimum total stage living biomass to meet human nutrient needs, as in Table 11.

Table 11. Total living biomass (L_{tot}) required for a single species to meet a nutritional need per day. For example, if barley was the only crop in the farm, 442 kg of total living biomass in the Barley Hydroponic Stage, including yet to be harvested plants, would be needed to meet the 2,000 kcal daily human requirement.

Species	Kcal	Carbohydrate**	Fats	Proteins	Fiber	N*
Barley	442	451	2,389	313	113	24,401
Bell Peppers	25,537	20,609	115,409	17,237	9,576	31,336
Chlorella	58	159	86	10	950	1
Pinto Beans	163	195	1,616	66	46	1,488
Potatoes	2,123	1,712	63,834	1,993	1,008	6,234
Rice	166	135	2,035	111	126	3,204
Shrimp	1,297	N/A	7,618	137	N/A	395
Silver Carp	2,383	N/A	1,910	442	N/A	4,355
Soybeans	360	1,251	273	102	157	1,317
Spirulina	297	620	697	32	242	12
Tilapia	1,515	N/A	3,008	183	N/A	695
Tomato	1,881	2,086	5,952	962	336	69
						0
Yeast from Yeast-Bacteria Reactor	2	5	2	1	1	1
HUMAN NEED	2000	0.32	0.07	0.05	0.03	0.01
* = Nitrogen here is a component of the Proteins mass.						
** = Non-fiber Carbohydrates, though need here includes all carbohydrates						

Therefore, Table 11 provides the maximum values to feed into the software solution model described below.

I. Scenario Descriptions

Four scenarios were examined: initial settlement (Scenario 1), sustained settlement (Scenario 2), steady state settlement (Scenario 3), and a supplying settlement (Scenario 4). Species are allocated to the scenarios as in Table 12.

Table 12. Species included in each scenario.

SPECIES	STAGE TYPE	SCENARIO				
		1A	1B	2A	2B	3+4
Barley	Hydroponic					X
Bell Peppers	Hydroponic			X	X	X
Chlorella	Algae Reactor	X	X	X	X	X
Pinto Beans	Hydroponic			X	X	X
Potatoes	Hydroponic			X	X	X
Rice	Hydroponic				X	X
Shrimp	Aquatic					X
Silver Carp	Aquatic					X
Soybeans	Hydroponic					X
Spirulina	Algae Reactor	X	X	X	X	X
Tilapia	Aquatic			X	X	X
Tomato	Hydroponic		X	X	X	X
Yeast-Bacteria Reactor	Yeast-Bacteria Reactor	X	X	X	X	X

1. Scenario 1 Initial Settlement (Settlement Level 0)

Two versions of this scenario were explored. One version, Scenario 1A, assumes only the Algae Reactors and Yeast-Bacteria Reactor were in operation, where the Yeast-Bacteria Reactor produces yeast biomass in addition to processing cellulose and waste biomass. Three types of food emerge, two algae species Chlorella and Spirulina, and Yeast biomass assumed to grow at, and be similar in nutrition, to Baker's Yeast (*Saccharomyces cerevisiae*).

A second version of scenario 1 (Scenario 1B) is as above, but also assumes a very limited growth of tomatoes in a nascent hydroponic stage, limited at most to 20 live kilograms of plants per person. This is a greater sized grow then on the ISS currently (2017), but far below a settlement of thousands.

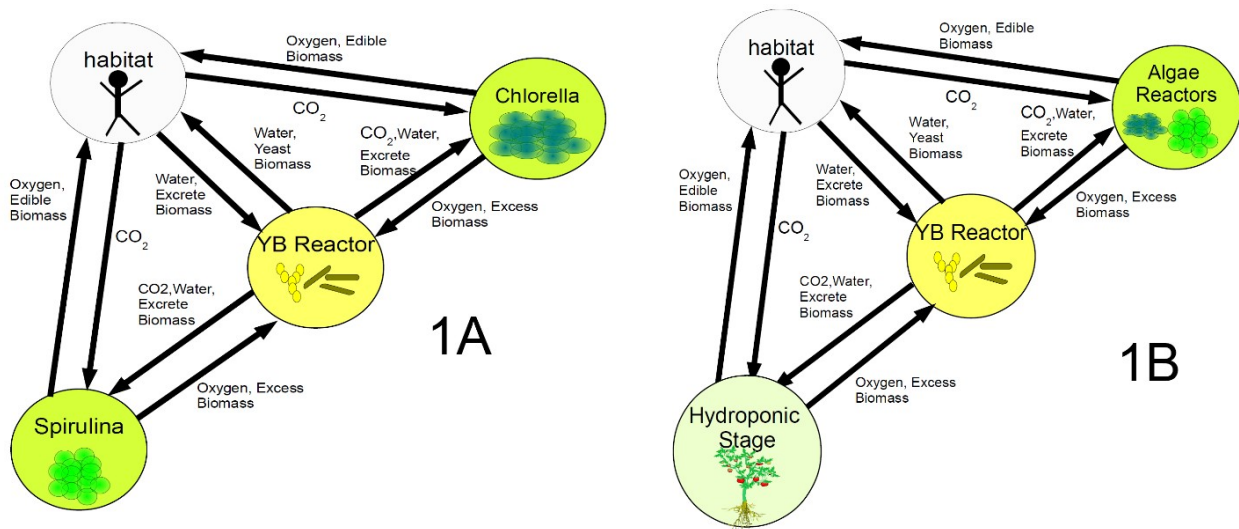

Figure 10. Scenarios 1A and 1B high level flows.

2. Scenario 2 Sustained Settlement (Settlement Level 1)

In Scenario 2, a sustained settlement with a self-sustaining and minimal resupply farm is assumed, though with minimal species as in Fig. 11. In one version, the scenario 2 (2A) farm, has no grains, and just one species (tilapia) in its Aquatic Stage with limited growth to 100 kg total tilapia living mass per person. Another version, Scenario 2B,

adds a grain (rice), and assumes a full size Aquatic Stage. In scenarios 2A and 2B, and remaining scenarios, the Yeast-Bacteria Reactor no longer produces human edible biomass, but is focused on balancing the space farm mass flow.

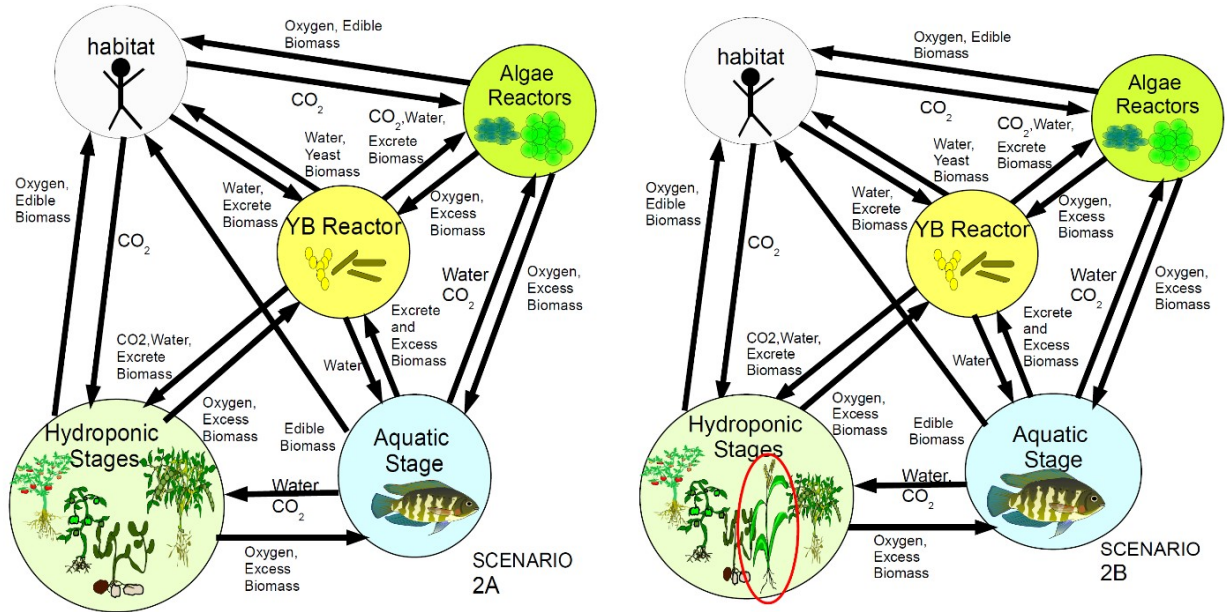

Figure 11. Scenarios 2A and 2B high level flows.

3. Scenario 3 Steady State Settlement (Settlement Level 2)

In Scenario 3, the full count of species is in the farm, with many aquatic species, targeted at the settlement's needs. Not including the Yeast-Bacteria Reactor, 12 species were examined with flows as in Fig. 12.

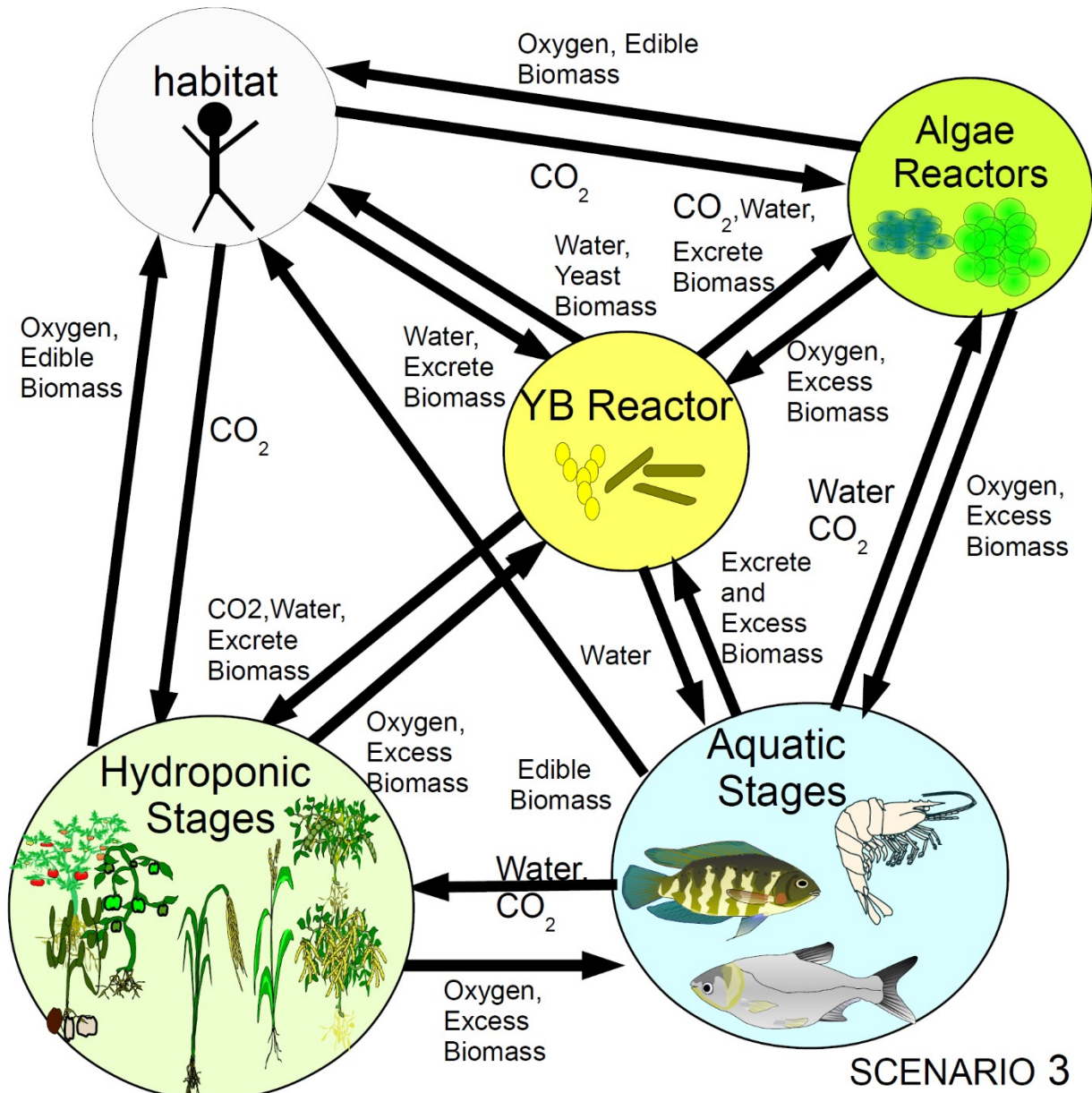

Figure 12. Scenario 3 high level flows.

4. Scenario 4 Supplying Settlement (Settlement Level 3)

Scenario 4 is similar to Scenario 3, and with the same species, though with the assumption that 50 kg/per day per person is supplied to the farm, in addition to the human outputs. This added input is assumed to be 20 kg in excrete biomass (Urea) and 30 kg of water person per day, designed to produce 50 kg per person per day in exports. This seed of initial mass alters the mass balance and sizing that emerges from the model below. In effect this adds 9.33 kg per person per day of nitrogen, with the 20 kg of urea recorded as excrete biomass for hydroponic and algae crops, and water to balance the rest of the farm.

J. Overall Mass Flow Model and Balancing Method and Model

All twelve species are allotted to a pool of possible species for each scenario, and a Monte-Carlo hybrid genetic method in a PERL/XML based simulator is used to select candidate solutions. The initial population (L_{tot}) seeds are chosen from the Table 11 values for each species above. Candidate farm solutions were scored based on these priorities: 1) ability to meet the human minimums for nutrition, water, and oxygen, 2) ability to balance mass across

the farm, 3) mass-minimal sizing. Energy in all cases is assumed to be freely available. For the Supplying Settlement (Scenario 4), the ability to produce hydroponic and aquatic crops for export adds a fourth criteria (i.e. greatest food biomass from both). The total population is randomized in a range, and top candidate populations for each species according to the criteria are used to tighten search range for each species living mass (L_{tot}) until a near-solution is obtained. Multiple solutions are possible. Initially the range is from 0 to maximum needed for human nutritional need. Each iteration tightens the range from the top 20 possible farm solutions that meet the four priorities. The Yeast-Bacterial Reactor population is adjusted based on conversion flows in biomass and need to produce carbon dioxide, water, or biomass, and is calculated initially from the software, though may be adjusted to reflect actual mass flows, as in the Table 13.

Table 13. Yeast-Bacteria Reactor Stage mass processing calculations for model. *Equations used to size the Yeast-Bacteria Reactor in the software model.*

common name	Contribution to Yeast-Bacteria Reactor mass processed
Barley	$B_{o,g} * L_{crop}/L_{tot} + B_i$
Bell Peppers	$B_{o,g} * L_{crop}/L_{tot} + B_i$
Chlorella	$B_{o,g} * L_{crop}/L_{tot} + B_i$
Pinto Beans	$B_{o,g} * L_{crop}/L_{tot} + B_i$
Potatoes	$B_{o,g} * L_{crop}/L_{tot} + B_i$
Rice	$B_{o,g} * L_{crop}/L_{tot} * B_i$
Shrimp	$B_{o,excrete} + L_{crop}/L_{tot} * B_{o,g}$
Silver Carp	$B_{o,excrete} + L_{crop}/L_{tot} * B_{o,g}$
Soybeans	$B_{o,g} * L_{crop}/L_{tot} + B_i$
Spirulina	$B_{o,g} * L_{crop}/L_{tot} + B_i$
Tilapia	$B_{o,excrete} + L_{crop}/L_{tot} * B_{o,g}$
Tomato	$B_{o,g} * L_{crop}/L_{tot} + B_i$
Yeast as Crop	B_o

IV. Results

A. Scenarios 1A and 1B.

In these scenarios, the solution sought to use yeast entirely, but once forced away from that path, chose a more diverse balance. Given the nature of use of L_{tot} , M , and V in calculations, these are the smallest farms. Note, in all scenarios, a septic tank of 6 metric tons will also be required. Note also that given the software method, many solutions are possible in addition to the ones presented.

1. Scenario 1A

Scenario 1A was a strictly bioreactor scenario, consisting of only Chlorella, Spirulina, and yeast from the Yeast-Bacteria Reactor. After 350,000 runs, a near solution converged as in Table 14.

Table 14. Scenario 1A solution sizes. *One possible near solution had a total living biomass of 3kg of Chlorella, 3kg of Spirulina, and 1 kg of Yeast that produces yeast for food.*

Species	Stage Type	Per person		For 100 settlers	
		L _{tot}	L _{crop}	L _{tot}	L _{crop}
Chlorella	Algae Reactor	3	2.2	300	220
Spirulina	Algae Reactor	3	0.75	300	75
Yeast	Yeast-Bacteria Reactor	1	0.5	100	50
		Live kg	Live kg	Live kg	Live kg

Table 15. Scenario 1A farm size for 100 settlers. *Farm sizes including the mass and volume for each stage.*

Species	Stage Type	For 100 Settlers			
		Volume	Mass	Water Mass	Footprint*
Chlorella	Algae Re-actor	1,617	1.87	1.35	0.05
Spirulina	Algae Re-actor	1,617	1.62	1.16	0.05
Yeast	Yeast-Bac-teria Reac-tor	273	0.62	0.45	0.01
Y-B Re-actor as Proce-ssor	Yeast-Bac-teria Reac-tor	2,402	5	4	0.08
TOTAL		5,910	9.58	6.91	0.20
*= <i>assumes 3m height</i>		m ³	metric tons	metric tons	Hectares

In this scenario, shown in Table 15, the Algae Reactors together dominate the footprint, though the overall footprint must deal with the need for carbon dioxide for the algae and cyanobacteria, leading to aerobic respiration, thus driving the Yeast-Bacteria Reactor's footprint.

Table 16. Scenario 1A mass flows.

For 100 settlers, kg								
	Inputs				Outputs			
Species	CO ₂	H ₂ O	O ₂	Biomass in (total)	CO ₂	H ₂ O	O ₂	Biomass out (total)
Chlorella	61	372	0	5	0	357	45	37
Spirulina	49	312	0	5	0	299	35	31
Yeast	0	676	253	3	349	253	0	331
TOTAL	110	1360	253	13	349	909	80	399

The Yeast-Bacteria Reactor as a whole however dominates mass flow due to the need to produce yeast food and carbon dioxide. Initial masses required to set up the farm for scenario 1A are driven by the water in the reactors and shown in Table 17, and contain large water masses due to the nature of the bioreactors used.

Table 17. Scenario 1A initial masses. *Structure mass is computed by subtracting water mass in Table 15 from total mass. In total, 696 metric tons would be required to field this farm, as an upper bound. 365 days is an upper limit on the required initial mass.*

100 settlers				
INPUTS	In stage (kg)	1 day kg	365 days in kg	Total in metric tons
Water	6,911	1,360	503,321	510
CO ₂		110	40,087	40
Oxygen		253	92,519	93
Nitrogen		25	9,285	9
Sulfur		14	5,179	5
Ash (Minerals)		95	34,785	35
LIVING MASS				1
Structures and Equipment (minimum)				3
TOTAL				696

2. Scenario 1B

Scenario 1B adds a small hydroponic stage with tomatoes, to the reactors in scenario 1A. After 450,000 runs a near solution emerged as shown in Table 18.

Table 18. Scenario 1B solution sizes.

Species	Stage Type	Per person		For 100 Colonists	
		L _{tot}	L _{crop}	L _{tot}	L _{crop}
Chlorella	Algae Reactor	3	2	300	220
Spirulina	Algae Reactor	1	0.25	100	25
Yeast	Yeast-Bacteria Reactor	0.5	0.25	50	25
Tomato	Hydroponic	15	14	1500	1364
		Live kg	Live kg	Live kg	Live kg

Adding a hydroponic stage shifted some of the living biomass in the farm to the hydroponic garden, due to the mass of the tomato 'trees' that produce the tomato fruit harvest.

Table 19. Scenario 1B stage mass and volume.

Species	Stage Type	For 100 Settlers			
		Volume	Mass	Water Mass	Footprint*
Chlorella	Algae Reactor	1,617	1.87	1.35	0.05
Spirulina	Algae Reactor	539	0.54	0.39	0.02
Tomato	Hydroponic	1,616	2.06	0.33	0.05
Yeast-Bacteria Reactor	Yeast-Bacteria Reactor	1,724	3.93	2.84	0.06
TOTAL		5,496	8.40	4.90	0.18
*=assumes 3m height		m ³	metric tons	metric tons	hectares

The algae reactors still dominate the footprint (Table 19) of the solution, but the tomatoes offset a significant volume due to the aerial portion, but are less in water mass due to their small root volume versus wet mass of fruit produced, and the low need for overgrowth.

Table 20. Scenario 1B mass flows.

Species	For 100 settlers, kg							
	Inputs				Outputs			
	CO ₂	H ₂ O	O ₂	Biomass in (total)	CO ₂	H ₂ O	O ₂	Biomass out (total)
Chlorella	61	372	0	5	0	357	45	37
Spirulina	16	104	0	2	0	100	12	10
Yeast	0	338	127	1	174	126	0	166
Tomato	7	42	0	0	0	39	5	5
TOTAL	84	856	127	9	174	622	62	217

The mass flow is still dominated by water and carbon dioxide going into the algae reactors and biomass and oxygen into the Yeast-Bacteria Reactor.

Initial mass for this solution (Table 21) is smaller than in 1A (Table 17) due to the smaller Yeast-Bacteria Reactor and Spirulina Algae Reactor, and due to the use of vascular plants (i.e. tomatoes) to efficiently process wastes into food.

Table 21. Scenario 1B initial masses. 365 days is an upper limit on the required initial mass.

INPUTS	100 settlers			Total in metric tons
	In stage (kg)	1 day kg	365 days in kg	
Water	22,915	856	335,201	358
CO2		84	30,744	31
Oxygen		127	46,260	46
Nitrogen		14	5,276	5
Sulfur		2	588	1
Ash (Minerals)		270	98,545	99
LIVING MASS				2
Structures and Equipment (minimum)				4
TOTAL				546

B. Scenarios 2A and 2B.

These scenarios add in complex set of hydroponic crops (7 in 2A, 8 in 2B), removed the yeast as food option, and add a limited aquatic stage with only tilapia.

1. Scenario 2A

In scenario 2A, there were seven hydroponic crops, none of which are grains, and an initially limited sized aquatic stage. After 470,000 runs, a near solution emerged as in Table 22.

Table 22. Scenario 2A solution masses.

Species	Stage Type	Per person		For 100 Settlers	
		L _{tot}	L _{crop}	L _{tot}	L _{crop}
Bell Peppers	Hydroponic	16	1	1,600	77
Chlorella	Algae Reactor	14	10	1,400	1,027
Pinto Beans	Hydroponic	32	1	3,200	136
Potatoes	Hydroponic	92	7	9,200	697
Spirulina	Algae Reactor	7	2	700	175
Tilapia	Aquatic	2	0	200	12
Tomato	Hydroponic	30	27	3,000	2,727
		Live kg	Live kg	Live kg	Live kg

Adding a series of hydroponic crops shifted live biomass to hydroponic stages.

Table 23. Scenario 2A stage sizes and footprint for 100 settlers.

Species	Stage Type	Volume	Mass	Water Mass	Footprint*
Bell Peppers	Hydroponic	543	1.78	0.02	0.02
Chlorella	Algae Reactor	7,546	8.72	6.30	0.25
Pinto Beans	Hydroponic	3,068	3.82	0.22	0.10
Potatoes	Hydroponic	2,676	10.42	0.23	0.09
Spirulina	Algae Reactor	3,774	3.77	2.70	0.13
Tilapia	Aquatic	17	11.92	8.00	0.00
Tomato	Hydroponic	3,232	4.12	0.66	0.11
Yeast-Bacteria Reactor	Yeast-Bacteria Reactor	2,453	5.59	4.04	0.08
TOTAL		23,308	50.15	22.17	0.78
*=assumes 3m height		m ³	metric tons	metric tons	hectares

Notice that adding crop diversity increases footprint in Table 23, especially due to the volumes of hydroponic stages, though the algae bioreactors are still significant in this particular solution. A real farm would have to throttle the bioreactors, though this may also illustrate over pessimism in V and M multipliers for the bioreactors. The model software is attracted to the bioreactors due to mass flow efficiency, and the M and V multipliers magnify this preference.

Table 24. Scenario 2A mass flows.

Species	For 100 settlers, kg							
	Inputs				Outputs			
	CO ₂	H ₂ O	O ₂	Biomass in (total)	CO ₂	H ₂ O	O ₂	Biomass out (total)
Bell Peppers	20	170	0	1	0	162	16	14
Chlorella	286	1,734	0	24	0	1,664	208	171
Pinto Beans	1,189	424	0	52	0	147	865	653
Potatoes	350	682	0	234	0	802	254	210
Spirulina	113	728	0	12	0	698	82	72
Tilapia	0	16	5	330	7	16	0	328
Tomato	91	558	0	6	0	521	73	62
TOTAL	2,049	4,311	5	659	7	4,010	1,497	1,511
Yeast-Bacteria Reactor Mass Processed Min					897			

The Yeast-Bacteria Reactor makes up for a carbon dioxide input requirement in Table 24, which then largely feeds pinto beans, which provide silage for the Yeast-Bacteria Reactor to make carbon dioxide. Tilapia do not provide enough carbon dioxide in the scenario to offset the need for the Yeast-Bacteria Reactor.

For initial inputs, shown in Table 25, water is again a driver, and the diversity of stages adds mass in this solution, especially even the small Aquatic Stage.

Table 25. Initial mass required for Scenario 2A. 365 days is an upper limit on the required initial mass.

100 settlers				
INPUTS	In stage (kg)	1 day kg	365 days in kg	Total in metric tons
Water	22,169	4,311	1,595,732	1,618
CO2		2,049	747,823	748
Oxygen		5	1,766	2
Nitrogen		89	32,544	33
Sulfur		40	14,715	15
Ash (Minerals)		254	92,571	93
LIVING MASS				19
Structures and Equipment (minimum)				28
TOTAL				2,556

2. *Scenario 2B*

Scenario 2B is as 2A but with the addition of rice, and unlimited sizing on tilapia. After 850,000 runs a near solution emerged as in Table 26.

Table 26. Scenario 2B solution masses.

Species	Stage Type	Per person		For 100 Settlers	
		L_{tot}	L_{crop}	L_{tot}	L_{crop}
Bell Peppers	Hydroponic	14	0.67	1400	67
Chlorella	Algae Reactor	9	6.6	900	660
Pinto Beans	Hydroponic	17	0.72	1700	72
Potatoes	Hydroponic	5	0.38	500	38
Spirulina	Algae Reactor	4	1	400	100
Tilapia	Aquatic	4	0.24	400	24
Tomato	Hydroponic	20	18.18	2000	1818
Rice	Hydroponic	21	0.7	2100	70
		Live kg	Live kg	Live kg	Live kg

Even with tilapia unlimited, their biomass only slightly increases in this solution, while hydroponics overshadow the reactors. The model is attracted to the rice due to the high carbohydrate density in the grain.

Table 27. Scenario 2B farm sizes and footprint.

Species	Stage Type	For 100 settlers, kg			
		Volume	Mass	Water Mass	Footprint*
Bell Peppers	Hydroponic	475	1.56	0.0138	0.016
Chlorella	Algae Reactor	4,851	5.61	4.05	0.162
Pinto Beans	Hydroponic	1,630	2.03	0.12	0.054
Potatoes	Hydroponic	145	0.57	0.01	0.005
Spirulina	Algae Reactor	2,156	2.16	1.54	0.072
Tilapia	Aquatic	33	23.84	16.00	0.001
Tomato	Hydroponic	2,154	2.75	0.44	0.072
Rice	Hydroponic	5,863	2.71	0.34	0.195
Yeast- Bacteria Reactor	Yeast-Bacteria Reactor	5,090	4.62	3	0.17
TOTAL		22,399	46	26	0.75
*=assumes 3m height		m ³	metric tons	metric tons	Hectares

Footprint is now driven, as in Table 27, by a combination of the reactors and hydroponic stages, though the Yeast-Bacteria Reactor is the second largest single stage. The Aquatic Stage raceways increase farm total mass due to water. In these flows (Table 28), the Algae Reactor outputs and silage from the beans and rice in the Hydroponic Stages

Table 28. Scenario 2B mass flows.

Species	For 100 settlers, kg							
	Inputs				Outputs			
	CO ₂	H ₂ O	O ₂	Bio-mass in (total)	CO ₂	H ₂ O	O ₂	Bio-mass out (total)
Bell Peppers	18	149	0	1	0	142	14	12
Chlorella	184	1115	0	15	0	1070	134	110
Pinto Beans	632	225	0	28	0	78	459	347
Potatoes	19	37	0	13	0	44	14	11
Spirulina	65	416	0	7	0	399	47	41
Tilapia	0	31	10	660	13	31	0	656
Tomato	60	372	0	4	0	347	49	41
Rice	765	319	0	15	0	39	572	489
TOTAL	1743	2664	10	742	13	2150	1288	1709
Yeast-Bacteria Reactor Mass Processed Min					1861			

(once processed) are consumed by the tilapia. Tilapia in real life can directly consume algae, and in fact grow well on raw algae and silage. In turn, tilapia excretes go through the Yeast-Bacteria Reactor to make carbon dioxide and nutrients for the algae, and in a small way add nutrients for the beans and rice. The silage from the beans and rice also return as carbon dioxide and water to the algae, beans, and rice. The potatoes and bell peppers are only a minor player in this solution, due to the time to produce the crop.

In initial mass, Table 29, water is again a driver, though carbon dioxide is significant in this solution as well.

Table 29. Scenario 2B initial masses. 365 days is an upper limit on the required initial mass.

INPUTS	100 settlers			Total in metric tons
	In stage (kg)	1 day kg	365 days in kg	
Water	25,858	2,664	998,202	1,026
CO2		1,743	636,042	636
Oxygen		10	3,532	4
Nitrogen		1	425	0.4
Sulfur		0.4	155	0.2
Ash (Minerals)		55	20,244	20
LIVING MASS				9.4
Structures and Equipment (minimum)				20
TOTAL				1,716

C. Scenario 3.

Scenario 3 uses all twelve species, and seeks mass balance. After 1.9M runs a near solution emerged as in Table 30.

Table 30. Scenario 3 solution masses.

Species	Stage Type	Per person		For 100 Settlers	
		L _{tot}	L _{crop}	L _{tot}	L _{crop}
Barley	Hydroponic	50	0.67	5000	67
Bell Peppers	Hydroponic	23	1.11	2300	111
Chlorella	Algae Reactor	5	3.67	500	367
Pinto Beans	Hydroponic	20	0.85	2000	85
Potatoes	Hydroponic	14	1.06	1400	106
Rice	Hydroponic	7	0.23	700	23
Shrimp	Aquatic	34	2.58	3400	258
Silver Carp	Aquatic	30	0.75	3000	75
Soybeans	Hydroponic	54	1.44	5400	144
Spirulina	Algae Reactor	5	1.25	500	125
Tilapia	Aquatic	10	0.61	1000	61
Tomato	Hydroponic	14	12.73	1400	1273
		Live kg	Live kg	Live kg	Live kg

The algae bioreactors are a small player in this diverse species set, around 4% of all living biomass, though barley and soybeans emerge as the largest living masses in this solution due to nutrient density. In the Aquatic Stages, silver carp can be very densely packed in raceways, using less space than either tilapia or shrimp, though shrimp become an attractor due to their protein density.

Table 31. Scenario 3 total farm sizes and footprint.

		For 100 settlers			
Species	Stage Type	Volume	Mass	Water Mass	Footprint*
Barley	Hydroponic	18512	6.15	0.57	0.62
Bell Peppers	Hydroponic	781	2.56	0.02	0.03
Chlorella	Algae Reactor	2695	3.12	2.25	0.09
Pinto Beans	Hydroponic	1918	2.39	0.14	0.06
Potatoes	Hydroponic	407	1.59	0.04	0.01
Rice	Hydroponic	1954	0.9	0.11	0.07
Shrimp	Aquatic	733	524.06	357.94	0.02
Silver Carp	Aquatic	128	91.4	60.01	0.00
Soybeans	Hydroponic	8982	6.85	0.71	0.30
Spirulina	Algae Reactor	2696	2.69	1.93	0.09
Tilapia	Aquatic	83	59.6	40	0.00
Tomato	Hydroponic	1508	1.92	0.31	0.05
subtotal		40397	703	464.02	1.35
Yeast- Bacteria Reactor	Yeast-Bacteria Reactor	8157	19	13	0.27
TOTAL		48554	722	477.45	1.62
*=-assumes 3m height		m ³	metric tons	metric tons	hectares

Barley are shown in this solution (as in Table 31) to be a very footprint intensive crop, though rich in complex carbohydrates, and essential for making malts for beer and whisky production. Barley, however, has a long growing cycle, driving a larger L_{tot}/L_{crop} ratio.

Both soybeans and barley, due to large living masses, require large inputs of carbon dioxide and water. More water is for soybeans, which are a water-intensive crop, as seen in Table 32.

Table 32. Scenario 3 mass flows.

Species	For 100 settlers, kg							
	Inputs				Outputs			
	CO ₂	H ₂ O	O ₂	Biomass in (total)	CO ₂	H ₂ O	O ₂	Biomass out (total)
Barley	1447	817	0	38	0	300	1052	950
Bell Peppers	29	244	0	2	0	233	22	20
Chlorella	102	619	0	8	0	594	74	61
Pinto Beans	743	265	0	32	0	92	540	408
Potatoes	53	104	0	36	0	122	39	32
Rice	255	106	0	5	0	13	191	163
Shrimp	0	535	431	676	593	535	0	514
Silver Carp	0	250	463	538	636	511	0	103
Soybeans	3729	4233	0	493	0	2828	2208	3418
Spirulina	81	520	0	8	0	499	59	52
Tilapia	0	78	24	1650	33	78	0	1641
Tomato	42	260	0	3	0	243	34	29
TOTAL	6483	8032	918	3488	1262	6048	4220	7391
Yeast- Bacteria Reactor Mass Processed Min					3488			

Again, the Yeast-Bacteria Reactor must digest silage and fish wastes to provide carbon dioxide and water. This diverse farm also provides a very diverse menu with many food options.

Initial masses for Scenario 3 are far larger than in previous scenarios, the price of crop diversity, approaching almost seven kilotons.

Table 33. Scenario 3 initial masses. 365 days is an upper limit on the required initial mass.

INPUTS	100 settlers			Total in metric tons
	In stage (kg)	1 day kg	365 days in kg	
Water	477,453	8,032	2,931,680	3,409
CO ₂		6,483	2,366,143	2,366
Oxygen		918	334,912	335
Nitrogen		525	191,564	192
Sulfur		60	21,737	22
Minerals (Ash)		32	11,580	12
LIVING MASS				27
Structures and Equipment (minimum)				245
TOTAL				6,608

D. Scenario 4

Scenario 4 has the same species as Scenario 3, but supplies 20 kg of urea and 30 kg of water to get 50 kg of produce per person for export. The initial solution seed here started with a 20% solution for scenario 3, then added 1.5M runs to arrive at a near solution in Table 34.

Table 34. Scenario 4 solution.

Species	Stage Type	Per person		For 100 Settlers	
		L _{tot}	L _{crop}	L _{tot}	L _{crop}
Barley	Hydroponic	74	0.99	7400	99
Bell Peppers	Hydroponic	296	14.24	29600	1424
Chlorella	Algae Reactor	4	2.93	400	293
Pinto Beans	Hydroponic	82	3.49	8200	349
Potatoes	Hydroponic	105	7.95	10500	795
Rice	Hydroponic	26	0.87	2600	87
Shrimp	Aquatic	134	10.15	13400	1015
Silver Carp	Aquatic	78	1.94	7800	194
Soybeans	Hydroponic	15	0.4	1500	40
Spirulina	Algae Reactor	3	0.75	300	75
Tilapia	Aquatic	35	2.12	3500	212
Tomato	Hydroponic	110	100	11000	10000
		Live kg	Live kg	Live kg	Live kg

Bell peppers are the largest living mass in this solution followed by shrimp, tomatoes, and potatoes, while the algae reactors are again small by relative living mass.

Table 35. Scenario 4 farm size and footprint.

Species	Stage Type	For 100 settlers			
		Volume	Mass	Water Mass	Footprint*
Barley	Hydroponic	27398	9.1	0.85	0.91
Bell Peppers	Hydroponic	10051	32.9	0.29	0.34
Chlorella	Algae Reactor	2156	2.49	1.8	0.07
Pinto Beans	Hydroponic	7863	9.8	0.57	0.26
Potatoes	Hydroponic	3054	11.89	0.26	0.10
Rice	Hydroponic	7259	3.35	0.42	0.24
Shrimp	Aquatic	2891	2065.4	1410.69	0.10
Silver Carp	Aquatic	333	237.63	156.02	0.01
Soybeans	Hydroponic	2495	1.9	0.2	0.08
Spirulina	Algae Reactor	1617	1.62	1.16	0.05
Tilapia	Aquatic	291	208.61	140.02	0.01
Tomato	Hydroponic	11849	15.12	2.42	0.39
subtotal		77257	2600	1714.68	2.58
Yeast- Bacteria Reactor	Yeast-Bacteria Reactor	25190	65.42	47.27	0.84
TOTAL		102446	2665	1761.96	3.41
*=assumes 3m height		m3	metric tons	metric tons	hectares

Again the Yeast-Bacteria Reactor appears oversized from the software, magnifying the footprint due to its high M and V as in Table 35. The added input mass to the farm, 5000 kg/day, drives a far larger farm solution than in Scenario 3, even without the Yeast-Bacteria Reactor. This is a more industrial farm, and like large scale farms on Earth, is oversized to produce outputs for export.

Table 36. Scenario 4 mass flows.

Species	For 100 settlers, kg							
	Inputs				Outputs			
	CO ₂	H ₂ O	O ₂	Bio-mass in (total)	CO ₂	H ₂ O	O ₂	Biomass out (total)
Barley	2142	1210	0	56	0	444	1558	1406
Bell Peppers	378	3146	0	19	0	2996	288	260
Chlorella	82	495	0	7	0	475	59	49
Pinto Beans	3047	1085	0	133	0	377	2215	1673
Potatoes	399	779	0	268	0	915	290	240
Rice	947	395	0	19	0	48	708	605
Shrimp	0	2109	1698	2663	2335	2109	0	2026
Silver Carp	0	651	1203	1398	1654	1328	0	269
Soybeans	1036	1176	0	137	0	786	613	950
Spirulina	49	312	0	5	0	299	35	31
Tilapia	0	273	85	5775	116	274	0	5742
Tomato	332	2045	0	21	0	1909	268	228
TOTAL	8412	13676	2985	10501	4106	11961	6035	13478
Yeast- Bacteria Reactor Mass Processed Min						9211		

In this solution, barley and the legumes (i.e. the beans) dominate carbon dioxide inputs, and shrimp and tilapia

Table 37. Scenario 4 initial masses. 365 days is an upper limit on the required initial mass.

INPUTS	100 settlers			Total in metric tons
	In stages (kg)	1 day kg	365 days in kg	
Water	1,761,956	13,676	6,753,825	6,754
CO ₂		8,412	3,070,370	3,070
Oxygen		2,985	1,089,629	1,090
Nitrogen		2,016	735,728	736
Sulfur		1,042	380,330	380
Ash (Minerals)		2,016	735,728	736
LIVING MASS				96
Structures and Equipment (minimum)				903
TOTAL				13,765

dominate biomass outputs, due to excretions, though neither dominate edible biomass out. Assuming edible biomass output is in ratio to export biomass, tomatoes would dominate as in Figure 13, followed by Chlorella and Pinto Beans in wet mass. That said, once dried out, Chlorella would be a minor output by dry mass. It is assumed buyers would

want fresh vegetables, and would have means to transport them, though failing that, the grains and beans could become a very important export. No doubt that the settlement would also use a small amount of grain and potatoes to make fermented (and maybe distilled) products for higher value export, especially when combined with spices grown inside the habitat.

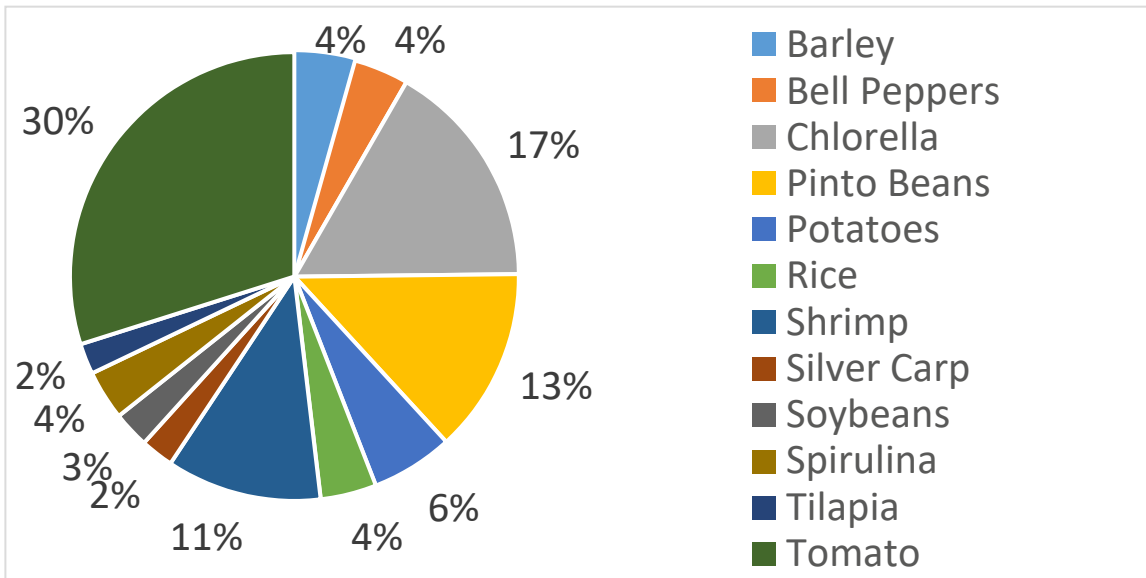

Figure 13. Export biomass by percentage.

E. Scenario Summary

Table 38 shows a summary for all scenarios for the solutions found. While many solutions are possible for each

Table 38. Summary table for solutions found for all scenarios.

Scenario	TOTALS (100 Settlers)		
	Volume (cubic meters)	Foot-print (hectares)*	Initial Mass (metric tons)
1A	5,910	0.2	696
1B	5,496	0.18	546
2A	23,308	0.78	2,556
2B	22,399	0.75	1,716
3	48,554	1.62	6,608
4	102,446	3.41	13,765

* = assumes 3 meter height

scenario due to the modeling software used and problem set in this paper, the solutions shown are reasonable given inputs. Note that for solutions 1B and 2B adding diversity in these cases reduced farm size, which may be due to either local minimum solutions in 1A and 2A, or to a limited increase in efficiency due to an added species. Forcing

full diversity in solution 3 definitely increased the size of the farm, as did adding input mass for solution 4, which forced the farm to grow to meet the added mass flows.

V. Conclusion

The Option A method, where a sized population is fed to the software model, provides realistic farm sizes for the farm, and solutions that are not unusual given prior work⁰, and believable due to use of more accurate field growth metrics. These sizes however, may prove overly optimistic given the need for walking space in the hydroponic beds, since legume and grain crops are serviced by combines and tractors in lieu of humans. Overall the bioreactors are still a key component as well, providing key pathways to move biomass types around the farm, and convert biomass to carbon dioxide for photosynthetic crops.

From a settlement perspective, diversifying the farm increased the size of the farm footprint and mass requirements, though also provide a far more diverse menu of foods and nutrients. Future farms will have to include many species to be both successful and make the farmers happy.

Appendix

Equipment to Manage Farm Mass Flows.

A variety of equipment is required to manage flows in the space farms described in this paper.

Below is a sampling of that equipment:

- Agitator /Infuser: a mixing blade and hose arrangement to stir thick liquids, and add gasses and liquids while stirring.
- Complex Control System: a series of controllers, network routers and cabling, sensor arrays, and software to manage each stage, each species in each stage, and the overall farm. These are similar to those in chemical factories and refineries, and will have a hierarchy architecture.
- Complex Manifold Liquid Router: shunts liquids based on chemical composition.
- Condenser: extracts liquid from a gas mix.
- Gas Extractor (from Liquid): extracts dissolved gasses from liquid.
- Gas Infuser w/Manifold: mixes gases into a liquid solution, then distributes the result into multiple pipes.
- Gas Pumps: Pumps to push gases (increase pressure)
- Gas Species Separator: pulls out one kind of gas from a mix of gasses.
- Intelligent valves: combinations of variable valves and simple processors and sensors to control flow and direction
- Liquid Pumps: self-priming pumps to push liquids (increase pressure).
- Macerating pump: takes coarse solids in liquid and mixes them into a fine mixed liquid
- Mass-Liquid Separator: pulls solids from a liquid mix.
- Reverse Osmosis Liquid Purifier: pushes liquid against a membrane to extract pure liquid (water) from a mixed liquid
- Ultraviolet Sterilizers: similar to current Pond/Pool Ultraviolet filters with multiple loops and sensors to assure sterile liquid/gas

Acknowledgments

The author would like to thank Space Colonization Technical Committee members, and the Equatorial Low Earth Orbit email list for constant productive feedback to evolve this farm concept, and improve my own understanding of how high density space farms will work, and Al Globus for a thorough technical review. Space is not just then and there, but here and now!

References

- ⁰Meyer, B.L., Shepherd, N.S.. "Nutrient Balance and Nitrogen Cycling In a Multistage, Multispecies Space Farm", AIAA SPACE 2016, AIAA SPACE Forum, (AIAA 2016-5586)
- ¹Meyer, B.L., "Of Fruits and Fishes: A Space Farm and Recycling Concept", AIAA SPACE 2015 Conference and Exposition, SPACE Conferences and Exposition, (AIAA 2015-4607)
- ²Wieser, M., Holden, N., Coplen, T., Bohlke, J., Berglund, M., Brand, W. et al. Atomic weights of the elements 2011 (IUPAC Technical Report), Pure Appl. Chem. Research Triangle Park, NC: International Union of Pure and Applied Chemistry, 2013.
- ³Jones, H. "Design Rules for Life Support Systems, 33rd International Conference on Environmental Systems (ICES) ." ICES40, 2003-01 -2356. Vancouver, BC: Society of Automotive Engineers, Inc, 2003.
<http://ntrs.nasa.gov/archive/nasa/casi.ntrs.nasa.gov/20040012725.pdf>.
- ⁴Guidance for Industry: A Food Labeling Guide, US Food and Drug Administration, January 2013
<http://www.fda.gov/downloads/Food/GuidanceRegulation/UCM265446.pdf>.
- ⁵Hausman, R. E.; Cooper, G. M. The cell: a molecular approach. 2004. Washington, D.C: ASM Press. ISBN 0-87893-214-3.
- ⁶Reeds, P.J., Dispensable and Indispensable Amino Acids for Humans, J. Nutr. July 1, 2000 vol. 130 no. 7 1835S-1840S.
- ⁷United States Department of Agriculture, Agricultural Research Service, National Nutrient Database for Standard Reference Release 28, May, 2016 Software v.2.6.1, <https://ndb.nal.usda.gov/ndb/foods>.
- ⁸Pearce, G.R., Lee, J.A., Simpson, R.J., Doyle, P.T. , "Sources of variation in the nutritive value of wheat and rice straws", Plant breeding and the nutritive value of crop residues, JUNE 1988 INTERNATIONAL LIVESTOCK CENTRE FOR AFRICA, <http://www.fao.org/Wairdocs/ILRI/x5495E/x5495e00.htm>.
- ⁹Tang, L. , Zhu, Y. , Hannaway, D. , Meng, Y. , Liu, L. , Chen, L. , Cao, W. , "RiceGrow: A rice growth and productivity model", NJAS - Wageningen Journal of Life Sciences, Volume 57, Issue 1, December 2009, Pages 83–92, doi:10.1016/j.njas.2009.12.003, <http://www.sciencedirect.com/science/article/pii/S1573521409000153>
- ¹⁰ed. Manns, R., Schmidt, S., Beveridge, C., PLANTS IN ACTION A resource for teachers and students of plant science, 2nd ed., c Australian Society of Plant Scientists, New Zealand Society of Plant Biologists, and New Zealand Institute of Agricultural and Horticultural Science 2010–2016, <http://plantsinaction.science.uq.edu.au/content/about>
- ¹¹Xing, Y. Wang, R. , Sun, W. , An, J. , Wang, C.X. , H.J. Bao, L. Gong, X. Z. Wang, "Effect of Balanced Fertilization on Rice Nutrient Uptake, Yield, and Profit", Better Crops/Vol. 93 (2009, No. 1), [http://www.ipni.net/publication/bettercrops.nsf/0/5C6E09CE82D30C73852579800070212E/\\$FILE/Better%20Crops%202009-1%20p4.pdf](http://www.ipni.net/publication/bettercrops.nsf/0/5C6E09CE82D30C73852579800070212E/$FILE/Better%20Crops%202009-1%20p4.pdf)
- ¹²Wu, C. , Feng, Y. , Shohag, M. J. I., Lu, L. , Wei, Y., Gao, C. , and Yang, X., "Characterization of 68Zn uptake, translocation, and accumulation into developing grains and young leaves of high Zn-density rice genotype", J Zhejiang Univ Sci B. 2011 May; 12(5): 408–418. doi: 10.1631/jzus.B1000291, <http://www.ncbi.nlm.nih.gov/pmc/articles/PMC3087098/>.
- ¹³Mueller, N. , "Plant Nutrient Analysis: Do your soybeans have the right stuff?" 7/25/2013, iGrow, South Dakota State University Brookings, SD. <http://igrow.org/agronomy/profit-tips/plant-nutrient-analysis-do-your-soybeans-have-the-rightstuff/#sthash.eHjNCXoD.dpuf>.
- ¹⁴"Soybean Growth and Development", February 19, 2015, Corn Agronomy, University of Wisconsin, 1575 Linden Drive - Agronomy, Madison WI 53706, <http://corn.agronomy.wisc.edu/Crops/Soybean/Default.aspx>
- ¹⁵Pedersen, P., "Soybean Growth Stages", ISU Extension publication, Soybean Growth and Development, 4/9/07, Copyright 2003-2016. , Iowa State University Extension.
- ¹⁶Hill, W., Pegg, M. Evaluating Asian Carp Colonization Potential and Impact in the Great Lakes Final Report to Illinois-Indiana Sea Grant. Champaign, IL: Sea Grant, 2008.
- ¹⁷Kapetsky, J.M.; Nath, S.S. A strategic assessment of the potential for freshwater fish farming in Latin America. COPESCAL Technical Paper. No. 10. Rome. FAO. 1997. 128p, ISBN 92-5-103989-5
<http://www.fao.org/docrep/005/W5268E/W5268E00.htm#TOC>
- ¹⁸Rakocy, J.E., Tank Culture Of Tilapia, The Fish Site, 5m Publishing, 01 Nov 2005, Sheffield, S35 1QN, England.
<http://www.thefishsite.com/articles/136/tank-culture-of-tilapia/>
- ¹⁹Kungvankij, P. , and Chua, T.E. , Shrimp Culture: Pond Design, Operation And Management, NACA Training Manual Series No. 2, Food and Agriculture Organization of the United Nations and Network of Aquaculture Centres in Asia (NACA), June 1986, <http://www.fao.org/docrep/field/003/ac210e/AC210E00.htm#TOC>.
- ²⁰Walker, S. J., ECOPHYSIOLOGY OF GROWTH IN THE PACIFIC WHITE SHRIMP (LITOPENAEUS VANNAMEI), Dissertation, Texas A&M University, May 2009
- ²¹Davis, D. A. , Rouse, D., Amaya, E., Zelaya, O., Venero, J., Quintero, H. , "Historical Review Of Feeding Protocols For The Pacific White Shrimp Litopenaeus Vannamei At Claude Peteet Mariculture Center, Gulf Shores, Alabama", AQUA 2006, World Aquaculture Society, Louisiana State University, Baton Rouge, LA, 2006.
- ²²Reed D.C., Rassweiler A, Arkema K.K., "Biomass rather than growth rate determines variation in net primary production by giant kelp", Ecology. 2008 Sep; 89(9):2493-505.
- ²³Danesi, E.D., Rangel-Yagui, C.O., Sato, S., Monteiro de Carvalho, J.C., "Growth and Content of Spirulina Platensis Biomass Chlorophyll Cultivated at Different Values of Light Intensity and Temperature Using Different Nitrogen Sources", Braz J Microbiol. 2011 Jan-Mar; 42(1): 362–373. doi: 10.1590/S1517-83822011000100046, <http://www.ncbi.nlm.nih.gov/pmc/articles/PMC3768952/>.
- ²⁴Pena, J. "Greenhouse Vegetable Production Economic Considerations, Marketing, and Financing." 30 05 2005. Texas A&M AgriLife Extension Service. 2015. <http://aggie-horticulture.tamu.edu/greenhouse/hydroponics/economics.html>.

- ²⁵Productivity: Crop Water Information: Tomato, WATER, FAO, 2015 http://www.fao.org/nr/water/cropinfo_tomato.html
- ²⁶Ulissi, V., Antonucci, F., Benincasa P., Farneselli M., Tosti G., Guiducci M., Tei F., Costa C., Pallottino F., Pari L. and Menesatti P., "Article Nitrogen Concentration Estimation in Tomato Leaves by VIS-NIR Non-Destructive Spectroscopy", *Sensors* 2011, 11, 6411-6424; doi:10.3390/s110606411 sensors ISSN 1424-8220 www.mdpi.com/journal/sensors
- ²⁷Van Hoek, P., Van Dijken, J.P., and Pronk, J.T. "Effect of Specific Growth Rate on Fermentative Capacity of Baker's Yeast", *Appl Environ Microbiol.* 1998 Nov; 64(11): 4226-4233.
- ²⁸Doucha, J., Straka, F., Livansky, K. "Utilization of flue gas for cultivation of microalgae (*Chlorella* sp.) in an outdoor open thin-layer photobioreactor." *Journal of Applied Phycology* (2005): 403-412.
- ²⁹Phukana M.M., Chutiab R.S., Konwara, B.K., Katak, R. "Microalgae *Chlorella* as a potential bio-energy feedstock", *Applied Energy* 88(10):3307-3312 • September 2011
- ³⁰Belasco, Warren (July 1997). "Algae Burgers for a Hungry World? The Rise and Fall of *Chlorella* Cuisine". *Technology and Culture* 38(3): 608-34. doi:10.2307/3106856. JSTOR 3106856, <https://www.jstor.org/stable/3106856>.
- ³¹"Seaweed, *Chlorella*, Dried" Nutrition facts, SELF Magazine, 2014 Conde Nast. <http://nutritiondata.self.com/facts/custom/569428/2>.
- ³²Csavina JL, Stuart BJ, Riefler RG, Vis ML., "Growth optimization of algae for biodiesel production", *J Appl Microbiol.* 2011 Aug;111(2):312-8. doi: 10.1111/j.1365-2672.2011.05064.x. Epub 2011 Jun 23.
- ³³Lurling, M., Eshetu, F., Faassen, E. J., Kosten, S. And Huszar, V. L. M. (2013), Comparison of cyanobacterial and green algal growth rates at different temperatures. *Freshwater Biology*, 58: 552-559. doi:10.1111/j.1365-2427.2012.02866.x.
- ³⁴Seltz, J. MEDITERRANEAN REGIONAL AQUACULTURE PROJECT, TECHNICS USED FOR INTENSIVE REARING AND ALIMENTATION OF FISH AND SHELLFISH, "Rearing Structures For Aquaculture" Ch. 10. Motta di Livenza, Italy: Food and Agricultural Organization of the United Nations, 1986.
- ³⁵"When to Harvest Fact Sheet", Rice Knowledge Bank, International Rice Research Institute (IRRI), <http://www.knowledgebank.irri.org/training/fact-sheets/item/when-to-harvest-fact-sheet>, captured 31 July 2017.
- ³⁶ed.J.L. Helm, K.F. Grafton, A.A. Schneiter, "Dry Bean Production Handbook", A-602 Revised, May 1990, NDSU EXTENSION SERVICE, North Dakota State University, Fargo, ND 58105
- ³⁷White, J., VARIATION IN WATER CONTENT OF YEAST CELLS CAUSED BY VARYING TEMPERATURES OF GROWTH AND BY OTHER CULTURAL CONDITIONS, *Journal of the Institute of Brewing*, Blackwell Publishing Ltd, 2050-0416, <http://dx.doi.org/10.1002/j.2050-0416.1952.tb02660.x>, 1952.
- ³⁸"The Barley Growth Guide, Winter 2005/06", 2006, HGCA, Caledonia House, 223 Pentonville Road, London N1 9HY.
- ³⁹"Production of Sweet Bell Peppers" Ag-Info Centre, Agriculture and Forestry, Government of Alberta, CA at [http://www1.agric.gov.ab.ca/\\$department/deptdocs.nsf/all/opp4523](http://www1.agric.gov.ab.ca/$department/deptdocs.nsf/all/opp4523), Revised on January 21, 2016 © 1995 - 2017.
- ⁴⁰O Charlo, HC; Oliveira, S.F.; Castoldi, R.; Vargas, P.F.; Braz, L.T.; Barbosa, J.C., "Growth analysis of sweet pepper cultivated in coconut fiber in a greenhouse" *Hortic. Bras.* vol.29 no.3 Brasília July/Sept. 2011 <http://dx.doi.org/10.1590/S0102-05362011000300010>
- ⁴¹Nunes, J.C.S.; Fontes, P.C.R.; Araújo, E.F.; Sedyama C. "Potato plant growth and macronutrient uptake as affected by soil tillage and irrigation systems" *Pesq. agropec. bras.* vol.41 no.12 Brasília Dec. 2006 <http://dx.doi.org/10.1590/S0100-204X2006001200014>
- ⁴²Tsegaw, T., Hammes, S., Robbertse, J., "Paclotrazol-induced Leaf, Stem, and Root Anatomical Modifications in Potato", *HortScience* August 2005 40:1343-1346, American Society for Horticultural Science, 2005.